

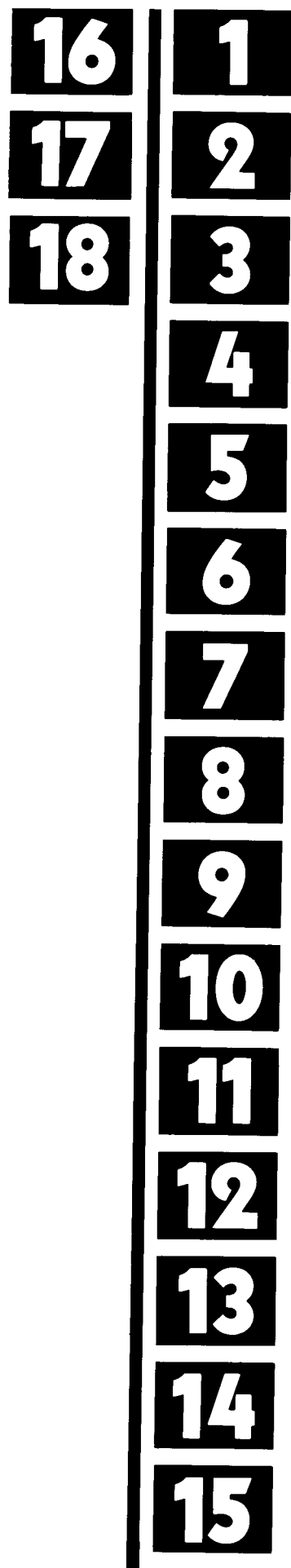

# KILN SERVICE HANDBOOK



# TABLE OF CONTENTS

Section	Pages
1. SAFETY .....	1.1 - 1.2
2. TROUBLESHOOTING .....	2.1 - 2.11
3. ELECTRICAL SERVICE .....	3.1
4. CONTROL PANEL .....	4.1 - 4.2
5. BUS BARS, U-TERMINALS AND INSULATORS .....	5.1 - 5.2
6. INFINITE SWITCHES .....	6.1 - 6.4
7. ELEMENTS .....	7.1 - 7.3
8. DAWSON KILN-SITTER .....	8.1 - 8.5
9. CONNECTING WIRES .....	9.1 - 9.5
10. COLLAR AND INTERCONNECT UNIT .....	10.1 - 10.4
11. WALL RECEPTACLES .....	11.1 - 11.2
12. CORDS .....	12.1 - 12.2
13. BRICK .....	13.1 - 13.5
14. PYROMETER .....	14.1 - 14.2
15. APPENDICES .....	15.1 - 15.20
APPENDIX A ES/DK 716 ELECTRICAL SCHEMATICS AND DIAGRAMS OF WIRING AND IDENTIFICATION OF PARTS .....	15.1 - 15.5
APPENDIX B ES/DK 820 ELECTRICAL SCHEMATICS AND DIAGRAMS OF WIRING AND IDENTIFICATION OF PARTS .....	15.6 - 15.10
APPENDIX C DK 820X/829 ELECTRICAL SCHEMATIC AND DIAGRAM OF WIRING AND IDENTIFICATION OF PARTS .....	15.11 - 15.13
APPENDIX D ES/DK 1020/1029 ELECTRICAL SCHEMATIC AND DIAGRAMS OF WIRING AND IDENTIFICATION OF PARTS .....	15.14 - 15.18
APPENDIX E DAWSON KILN-SITTER: CURRENT AND EARLY SERIES MODELS .....	15.19 - 15.20
16. GLOSSARY .....	16.1
17. INDEX .....	17.1 - 17.2
18. KILN WARRANTY .....	18.1 - 18.5

Most common repairs that any kiln owner may need to make are explained in detail in the *Duncan Kiln Owner's Manual*. This *Kiln Service Handbook* takes that information one step further. It covers all areas of repairs for Duncan kilns and gives correct methods and clear instructions for repair procedures. Cross-references are given whenever appropriate to make this handbook even more useful. Example: see 10.9 means refer to section 10, page 9.

First Edition March, 1978  
 Revised Edition November, 1978  
 Revised Edition March, 1983  
 Revised Edition April, 1985  
 Copyright, 1985, by Duncan Enterprises

All Rights Reserved.  
 This book, or parts thereof, may not be reproduced in any form without permission of the publishers.

# SAFETY

Duncan has taken all possible precautions — careful design, high quality-control standards and extensive electrical testing (both by the factory and by independent firms) — to produce a kiln that is safe to operate.

Duncan kilns have been certified by both Underwriters Laboratory (UL), the recognized United States authority on product safety, and by the Canadian Standards Association (CSA), the Canadian authority. Although the tests and submission procedures of both organizations are similar, there is no reciprocal acceptance of products tested. Therefore, a manufacturer wishing certification by both organizations must submit his product to each.

These certifications are important since it means recognized electrical parts are used which comply with all applicable UL or CSA safety standards, as well as with the provisions of the National Electrical Code and other nationally recognized installation and use codes.



Underwriters Laboratory Inc., an independent nonprofit corporation and nationally recognized authority on product safety, tests products for firms who wish to manufacture and identify their products as complying with UL standards.

Once a kiln — or any product — has a UL listing, no changes may be made in design or components until they have been approved and, if necessary, tested by UL. Unannounced factory inspections carried out by UL inspectors assure the consumer that UL's registered name or mark is applied only to those products authorized and that no unapproved changes have been incorporated. The frequency of these inspections will vary, depending on the product, firm, etc., from several times a week to a minimum of four visits per year.

In some areas of the United States, local ordinances restrict schools from purchasing appliances without the UL listing, and some cities prohibit the sale of specific items unless they carry the UL mark. Similar situations exist in Canada; there, it is the CSA listing which is required. As the seller of electric kilns, you should be aware of any laws or ordinances that may be in effect in your area. Contact your local (city, county, etc.) electrical inspection office for specific information.

The Duncan kiln repairperson has to do only a few things to make sure product safety is maintained. After every kiln repair, check the kiln for electrical soundness (see 2.8 - 2.10) and, for certain specified repairs, test-fire the kiln to be absolutely certain the kiln is operating properly.

*Before performing any kiln repair, be sure the kiln is unplugged or the power supply has been disconnected.*

Because an improperly installed kiln can be dangerous, we strongly suggest that only a qualified electrician install or check the house or studio wiring and this includes the wall receptacle. For your protection from possible legal action, *never remove even the faceplate from a wall receptacle unless you are a qualified electrician.*

# 1

When considering user safety, placement of a kiln is just as important as the electrical installation. Actually, this is up to the purchaser but, occasionally, you will have the opportunity to influence proper and safe positioning.

- A kiln should be positioned close to, but slightly to the left of, the appropriate electrical outlet or where a new circuit can be easily installed.
- A kiln should be located in a covered, well-ventilated area with adequate lighting.
- A minimum of 10 inches should be allowed between the kiln and the nearest wall or object.
- All flammable materials such as curtains, shelves, paper, etc. should be kept away from the kiln.
- A kiln should be placed on a level area where it can be easily loaded and operated; out of the way of children and other activities.
- The floor beneath the kiln should be of a material which cannot be discolored by heat and which will not present a fire hazard. Recommended floor surfaces are cement, ceramic tile, brick, stone, etc.
- A kiln should never be placed in a tightly enclosed area, such as a closet or cabinet, as air circulation is needed to prevent overheating.
- A kiln should never be placed in an area that restricts access to the peepholes or the control panel.

# TROUBLESHOOTING

Most kiln repair inquiries will come to you over the telephone. This is the time to ask the proper questions to try to determine what the problem really is. Complete facts can save diagnostic time or, occasionally, even the need for a service call. Specific questions to ask include: the model and serial number of the kiln; date purchased (to determine if it is under warranty); how often fired and to what cone; and exactly what is wrong.

Never overlook the obvious! If a customer complains that the entire kiln does not heat, do not hesitate to ask if the kiln is plugged in or if the circuit breaker has been tripped.

The Troubleshooting Chart here and on the following pages can be quite helpful when you have a customer on the telephone. Determining the possible causes of failure ahead of time will enable you to be sure you have the correct replacement parts and tools available to complete the job with as little inconvenience as possible for your customer.

## TROUBLESHOOTING CHART

SYMPTOM	PROBABLE CAUSE	REMEDY
<p><b>SLOW FIRING KILN</b>                      Many times this is not a valid complaint (see 6.3).</p> <p>(continued on page 2.2)</p>	<p><b>New Kiln</b></p> <ol style="list-style-type: none"> <li>1. Supply voltage lower than what kiln was manufactured for.</li> <li>2. Gauge of house wiring too small.</li> <li>3. Low service voltage</li> <li>4. Switch out of calibration.</li> <li>5. Defective switch.</li> <li>6. Any of the causes listed for slow firing on page 2.2.</li> </ol>	<ol style="list-style-type: none"> <li>1a. Replace with proper kiln. <i>or</i></li> <li>1b. If voltage is 110, consult electrician.</li> <li>2. Consult electrician.</li> <li>3a. Check with power company (3.1). <i>or</i></li> <li>3b. Increase heat settings and/or shorten firing schedule (6.3).</li> <li>4. Recalibrate or replace switch (6.2 or 6.4).</li> <li>5. Replace switch (6.4).</li> <li>6. See page 2.2.</li> </ol>

SYMPTOM	PROBABLE CAUSE	REMEDY
SLOW FIRING KILN (continued)	<p><b>Sudden Increase in Firing Time</b></p> <ol style="list-style-type: none"> <li>1. Unusually heavy load.</li> <li>2. Loose connection in kiln wiring.</li> <li>3. Loose connection in house wiring or wall receptacle.</li> <li>4. Section of kiln not heating.</li> <li>5. Voltage drop (brownout).</li> </ol> <p><b>Gradual Increase in Firing Time</b></p> <ol style="list-style-type: none"> <li>1. Elements wearing out.</li> </ol>	<ol style="list-style-type: none"> <li>1a. Reduce amount of ware. <i>or</i></li> <li>1b. Increase heat settings and/or shorten firing schedule (6.3).</li> <li>2. Tighten connection; replace any damaged parts.</li> <li>3. Consult electrician.</li> <li>4. See SECTION OF KILN DOES NOT HEAT in this chart.</li> <li>5. Check with power company (3.1).</li> </ol> <ol style="list-style-type: none"> <li>1a. Replace elements (7.2 - 7.3). <i>or</i></li> <li>1b. Increase heat settings and/or shorten firing schedule (6.3).</li> </ol>
KILN WILL NOT REACH MAXIMUM CONE	See SLOW FIRING KILN in this chart.	See remedies for SLOW FIRING KILN listed in this chart.
KILN WARMS BUT DOES NOT ATTAIN RED HEAT	Wall receptacle wired incorrectly.	<b><i>Dangerous; do not operate kiln</i></b> until electrician has checked wall receptacle.
SECTION OF KILN DOES NOT HEAT (if DK 716 model, entire kiln will not heat)	<p><b>Pilot Light On</b></p> <ol style="list-style-type: none"> <li>1. Defective element.</li> <li>2. Defective switch.</li> <li>3. Loose connection in kiln wiring.</li> <li>4. Broken connecting wire.</li> </ol> <p><b>Pilot Light Off</b></p> <ol style="list-style-type: none"> <li>1. Defective or loose connecting wire.</li> <li>2. Defective switch.</li> <li>3. If in collar section: <ol style="list-style-type: none"> <li>a. No contact between interconnect plug and receptacle.</li> <li>b. Defective interconnect receptacle and/or plug.</li> <li>c. Either defect listed in 1 or 2 above.</li> </ol> </li> </ol>	<ol style="list-style-type: none"> <li>1. Replace element (7.2 - 7.3).</li> <li>2. Replace switch (6.4).</li> <li>3. Tighten connection; replace any damaged parts.</li> <li>4. Replace wire (9.4).</li> </ol> <ol style="list-style-type: none"> <li>1. Replace or tighten connecting wire (9.1 - 9.4).</li> <li>2. Replace switch (6.4).</li> <li>3a. Adjust collar control panel down (10.1).</li> <li>3b. Replace defective unit(s) (10.3).</li> <li>3c. Use appropriate remedy.</li> </ol>

SYMPTOM	PROBABLE CAUSE	REMEDY
KILN WILL NOT HEAT AND PILOT LIGHT(S) NOT ON	<ol style="list-style-type: none"> <li>1. Kiln not plugged in.</li> <li>2. Kiln-sitter plunger not pushed in.</li> <li>3. Blown fuse or tripped circuit breaker.</li> <li>4. Defective kiln-sitter switch unit.</li> <li>5. One or more leads from cord not connected to kiln-sitter.</li> </ol>	<ol style="list-style-type: none"> <li>1. Plug cord into appropriate wall outlet.</li> <li>2. Push in plunger (<i>Owner's Manual</i>, page 14).</li> <li>3. See FUSE BLOWS OR CIRCUIT BREAKER TRIPS in this chart.</li> <li>4. Replace all or part of kiln-sitter switch (see Appendix H or I).</li> <li>5. Connect cord leads (12.2).</li> </ol>
ONE SECTION OF KILN CONSISTENTLY FIRES TOO HOT OR TOO COOL	<ol style="list-style-type: none"> <li>1. Some elements older than others.</li> <li>2. Switch out of calibration.</li> </ol>	<ol style="list-style-type: none"> <li>1a. Replace old elements (7.2 - 7.3). <i>or</i></li> <li>1b. Change heat settings to compensate for unevenness (6.2 - 6.3).</li> <li>2a. Recalibrate switch (6.2). <i>or</i></li> <li>2b. Change heat settings to compensate for unevenness (6.2 - 6.3).</li> </ol>
KILN SHUTS OFF BEFORE FIRING CONE IS MATURED	<ol style="list-style-type: none"> <li>1. Kiln-sitter out of adjustment.</li> <li>2. If kiln has safety timer, timer not set for enough time.</li> <li>3. Wrong cone in kiln-sitter.</li> </ol>	<ol style="list-style-type: none"> <li>1. Adjust kiln-sitter (8.1 - 8.2).</li> <li>2a. If kiln just shut off, reset timer and activate kiln-sitter. <i>or</i></li> <li>2b. Cool kiln, refire with new cones and timer set correctly (<i>Owner's Manual</i>, pages 8 and 21).</li> <li>3. Let kiln cool; refire with correct kiln-sitter cone.</li> </ol>
PILOT LIGHT OFF BUT KILN OPERATING	<ol style="list-style-type: none"> <li>1. Pilot light or its connecting wire defective.</li> <li>2. Loose connection.</li> <li>3. Defective switch.</li> </ol>	<ol style="list-style-type: none"> <li>1. Replace unit (9.3 - 9.4).</li> <li>2. Tighten connection.</li> <li>3. Replace switch (6.4).</li> </ol>
<p>FUSE BLOWS OR CIRCUIT BREAKER TRIPS</p> <p>First, reset breaker (or replace fuse) to be certain problem exists.</p>	<ol style="list-style-type: none"> <li>1. Short circuit in kiln wiring.</li> <li>2. Overloaded circuit.</li> <li>3. Inadequate, defective or improperly installed house wiring.</li> <li>4. Defective circuit breaker.</li> <li>5. Fuse box or circuit breaker located in place where it gets hot from kiln's heat.</li> </ol>	<ol style="list-style-type: none"> <li>1. Locate and correct short circuit (2.8).</li> <li>2. Disconnect any other appliances from circuit.</li> <li>3. Consult electrician.</li> <li>4. Have electrician replace.</li> <li>5. Move kiln or have electrician move wall receptacle.</li> </ol>

## TROUBLESHOOTING EQUIPMENT

# 2

### Element Tester

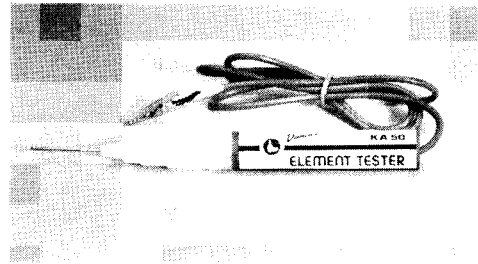

An element tester is a simple battery-powered circuit tester used to check for continuity in an electrical circuit. If the circuit being tested is complete (has continuity), the unit will light; if there is a break in the circuit, it will not. An element tester will only work in a low-resistance circuit of less than 10 ohms such as a single element.

Circuits with high resistance retard the flow of current so much, depending on the amount of resistance, that the unit will not light, not because there is no continuity, but because the resistance is too great for this particular tester. Any circuit exceeding 10 ohms must be tested with a multimeter; the chart on 2.11 lists the ohm readings for several troubleshooting tests done on a kiln.

Before using an element tester, test the batteries by touching the two probes together to be sure the unit lights. *Never use an element tester on a kiln that is connected to a power supply or live circuit.* If your unit has an alligator clip, use it in the same manner as you would a probe.

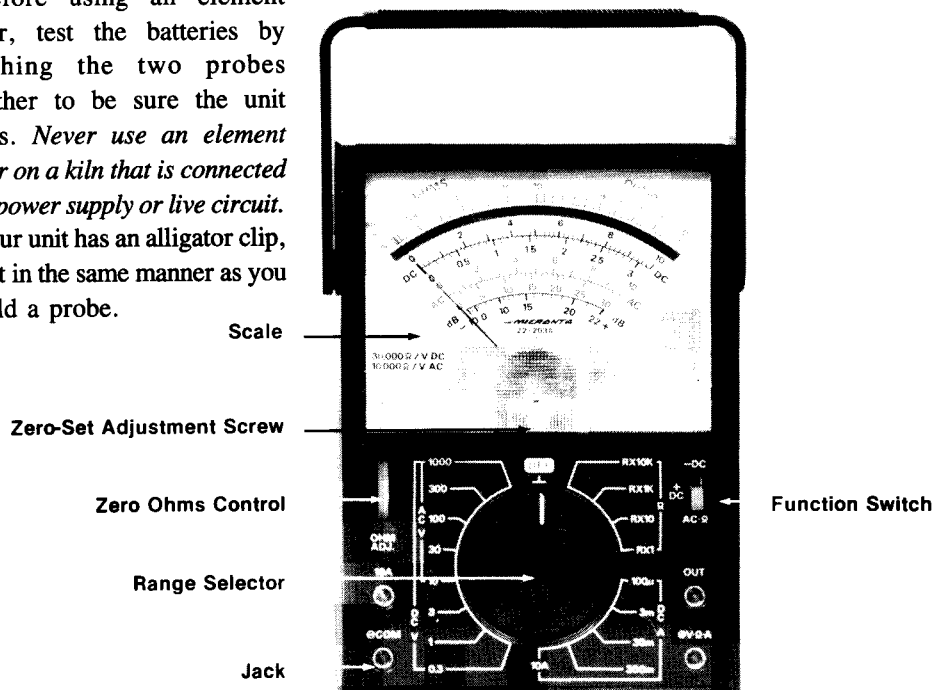

### Multimeter

A multimeter combines the features of an ammeter, voltmeter and ohmmeter into one instrument. Most multimeters require no external source of power. The power necessary for resistance measurements, common in kiln troubleshooting, is furnished by the meter's batteries.

When used in kiln troubleshooting, most readings will be done on the ohm scale (element resistance, etc.) but, occasionally, the need for volt readings will arise. When describing the features common to most multimeters, we have stressed how they relate to kiln troubleshooting. There is no question, a multimeter can be a real time-saver for a busy repairshop but, even more important, it is the best way to ensure the kiln's electrical safety after a repair.

**Scales** — On the face of the multimeter there are graduated scales for each function readable on the unit. Since the meter's needle is positioned slightly above the scale, an incorrect reading may occur when viewed from the side. To avoid this, the scale should be read from a position directly in front of, or above, the needle. Some meters have incorporated a mirror in the scale so that an incorrect reading may be readily seen, as the needle and its reflected image coincide when viewed from the proper angle.



The meter's ohm scale is not divided into uniform divisions. The largest divisions are usually at the right end, while the smaller divisions crowd in on the left end. The most accurate readings are obtained where the scale is most spread out. The volt scale on the meter has uniform divisions and the most accurate readings are found near the center of the scale.

**Zero-Set Adjustment Screw** — Care must be taken that the needle is properly adjusted before using a meter. Most meters are equipped with a screw adjustment which mechanically sets the needle at infinity ( $\infty$ ) on the left side of the scale.

**Zero Ohms Control** — This control adjusts the meter to compensate for battery aging when using the ohm scale. Set the range selector to the desired resistance range, touch the probes together and adjust this control until the needle registers zero ohms. If the needle cannot reach zero on the ohm scale, the batteries need replacing.

**Function Switch** — In kiln troubleshooting, the function switch would be used in the ohms ( $\Omega$ ) position when checking resistance and in the AC (alternating current) position when checking voltage.

**Range Selector** — The range selector allows the user to alter the meter scale so that the expected reading falls within the scale and the greatest degree of accuracy is obtained. **When reading ohms**, it is best to use a range where the reading will appear in the most spread-out portion of the scale. **When you need to read voltage**, be extremely careful not to allow more voltage to flow through the meter than the meter is set for or the meter may be damaged. If the voltage is unknown, always start with the highest range and work down until an acceptable reading is obtained. When the meter is not in use, the range selector should be placed in the **OFF** position or on a volt range.

**Jacks** — All meters have at least two jacks into which the test leads are inserted. Usually one jack is designated as **common** and used for all functions of the meter. If there are only two jacks, the other one would also be multipurpose. Sometimes, however, a meter will have a jack for each function. When reading ohms, either test lead can be plugged into either jack, but when voltage is being checked the negative (black) test lead must be connected to the negative jack (common), and the positive (red) test lead to the positive jack.

### Setting Multimeter for Ohm-Scale Reading

1. Place meter in correct position (check meter's instructions) on nonmetallic surface to ensure most accurate readings.
2. Adjust zero-set screw so needle rests exactly over infinity ( $\infty$ ) ohms at left side of scale.
3. Plug black test lead into common jack, and red into ohms ( $\Omega$ ) jack.
4. Set function switch to ohms position.
5. Set range switch to lowest ohm setting, usually R x 1.
6. While touching test probes together, adjust ohms adjust control so needle stabilizes over zero ohms. If needle will not reach zero, multimeter needs new batteries.

### Setting Multimeter for Volt-Scale Reading

1. Place meter in correct position (check meter's instructions) on nonmetallic surface to ensure most accurate readings.
2. Adjust zero-set screw so needle rests exactly over zero volts at left side of scale.
3. Plug black test lead into common jack, and red lead into volt (V) jack.
4. Set function switch to AC-volt position.
5. Set range switch on AC-volts range that includes expected voltage.

Avoid damaging your meter by not allowing more voltage to flow through the meter than it is set for. If the voltage is unknown, always start with the highest range and work down until an acceptable reading is obtained.

When using a multimeter to read volts, the following cautions must be observed:

*Only touch the insulated handles of the test probes. The test probes should come in contact only with item being tested. Do not allow them to touch each other or any other metallic surface.*

# TESTING PROCEDURES

The first thing to do before making any tests is to make sure your multimeter or element tester is operating correctly. The tests listed are for measuring resistance (ohms) or to ascertain whether or not there is continuity in the unit being tested.

## Testing Elements

1. **Unplug kiln.**
2. **Remove control panel (see 4.1).**
3. **Using multimeter:**
  - a. Set multimeter for ohm-scale reading (see 2.6).
  - b. Test each element within bank.
    - 1) Place test probes on each element end where it joins connector (U-terminal or bus bar).
    - 2) Compare ohm reading with chart (see 2.11) to establish correct resistance for that particular model's elements.
      - a) If multimeter's needle does not move, element is broken.
      - b) If ohms are much higher than they should be, element is worn out.
      - c) If ohms are much lower than they should be, there is a short circuit to be corrected (see 2.8).
      - d) If all readings are okay, problem may be a switch, connector or connecting wire.
4. **Using an element tester:**
  - a. Check element tester's batteries.
  - b. Place probes on each end of element where it joins connector (U-terminal or bus bar).
  - c. If tester does not light, element needs replacing.
  - d. If tester lights on all elements within bank, problem may be a switch, connector or connecting wire.

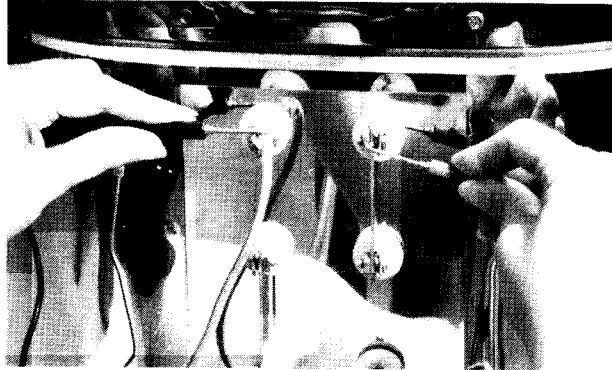

## Testing Switches

1. **Unplug kiln.**
2. **Remove control panel (see 4.1).**
3. **Disconnect all wires from switch.**
4. **Turn on switch.**
5. **Prepare troubleshooting equipment for use.**
  - a. Set multimeter for ohm-scale reading (see 2.6).

*or*

  - b. Check element tester's batteries.
6. **Check each circuit of switch by:**
  - a. Placing test probes on switch tabs  $H_1$  and  $L_1$ .
  - b. Placing test probes on switch tabs  $H_2$  and  $L_2$ .
7. **Switch is good, if:**
  - a. Troubleshooting equipment indicates continuity in both circuits, shown when:
    - 1) Element tester lights.

*or*

    - 2) Multimeter's needle swings to zero ohms at far right.
  - b. Switch is cycling correctly (see 6.2).

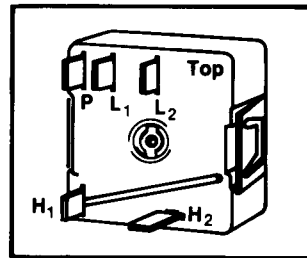

**8. Switch is defective if, on either circuit:**

a. Element tester does not light.

*or*

b. Multimeter's needle does not swing to zero ohms at far right.

**What is a circuit?** The path or paths through which electric current flows is called a **circuit**. The path of a circuit is a closed loop and any circuit which is complete, with no breaks, is called a **closed circuit**.

A **short circuit** or "short" is where the normal circuit is bypassed or current is flowing through the wrong path. This means it has found a shorter, easier route through which current should not be flowing, or at least not in the quantity it is. A short creates heat which can damage the kiln or its parts and can sometimes create a fire hazard, if the circuit breaker or fuse does not operate properly or is of too large a size. A circuit breaker or fuse is designed to protect the kiln and wiring from extensive damage from a short circuit. The fuse or circuit breaker senses an increase in the current and then interrupts the electrical circuit.

Shorts are usually caused by wires, metal parts or any two conductors, through which current is flowing, touching when they are not supposed to. A short can usually be found visually or with a multimeter or element tester, and potential shorts can be prevented if the wiring within the control panel is checked for frayed and deteriorated wires as recommended (see 4.1).

An **open circuit** is one in which the path is interrupted or broken, thus the current can no longer flow through it. An obvious example would be a broken element; the circuit (path) would be open and the elements would not heat as no current could flow. A multimeter or element tester can help locate an open circuit. If you have no idea where the problem is, the best way to isolate it is to check the largest circuit your equipment will read (a multimeter can check the resistance of a whole kiln, see 2.9), then check smaller and smaller portions of the circuit (each section, switch, etc.) until you find the problem. An open circuit is usually the result of a loose or broken connection (or the lack of a connection).

## Testing Kiln for Electrical Soundness

The following tests should be done in the interest of consumer safety whenever a repair is made that could affect the kiln's electrical components. *To be absolutely sure a kiln is electrically correct, do not omit any of these tests.*

### 1. Testing Kiln's Grounding\*

a. **Unplug kiln.**

b. **Prepare troubleshooting equipment for use.**

1) Set multimeter for ohm-scale reading (see 2.6).

*or*

2) Check element tester's batteries.

c. **Place test probes on plug's ground blade (round) and kiln case.**

d. **Kiln is not grounded properly, if:**

1) Multimeter's needle does not swing to zero ohms at far right.

*or*

2) Element tester does not light.

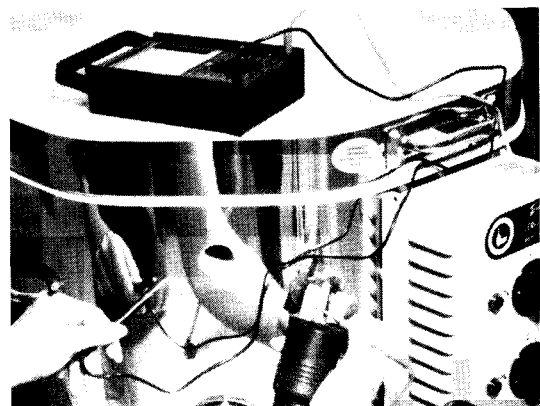

**e. To determine why kiln is not grounded:**

- 1) Place test probes on plug's ground blade (round) and cord's ground screw on side of control panel. If multimeter's needle does not swing to zero ohms or element tester does not light, cord is:
  - a) Not grounded properly.
  - b) Defective.
- 2) Place test probes on cord's ground screw on side of control panel and kiln case. If multimeter's needle does not swing to zero ohms or element tester does not light, make sure there is good contact between:
  - a) Control panel standoffs and kiln case.
  - b) Cord's grounding screw and control panel by removing control panel and checking that star washer is in place.

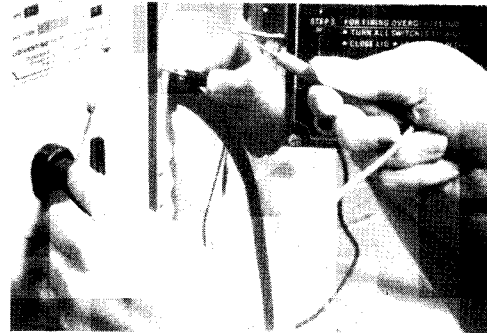
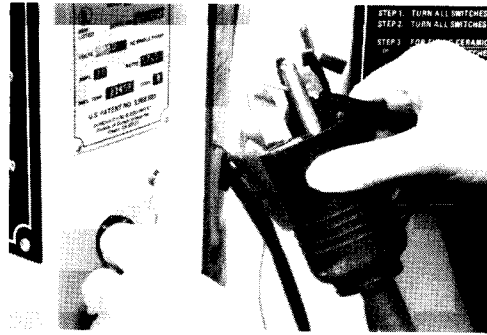

## 2. Testing for Short Circuits: Hot Wire to Ground.

- a. *Unplug kiln.*
- b. **Activate kiln-sitter.**
- c. **Turn on both switches.**
- d. **Prepare troubleshooting equipment for use.**
  - 1) Set multimeter for ohm-scale reading (see 2.6).
  - or*
  - 2) Check element tester's batteries.
- e. **Place test probes on plug's ground blade (round) and on one of plug's hot blades, then on other hot blade.**
- f. **A short circuit exists which must be corrected (see 2.8) if, on either circuit:**
  - 1) Multimeter's needle moves.
  - or*
  - 2) Element tester lights.

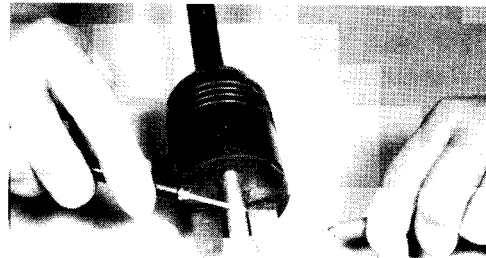

## 3. Testing for Short or Open Circuits: Hot Wire to Hot Wire

- a. *Unplug kiln.*
- b. **Activate kiln-sitter.**
- c. **Turn on both switches.**
- d. **Set multimeter\* for ohm-scale reading (see 2.6).**
- e. **Place one probe on each hot blade of plug.**

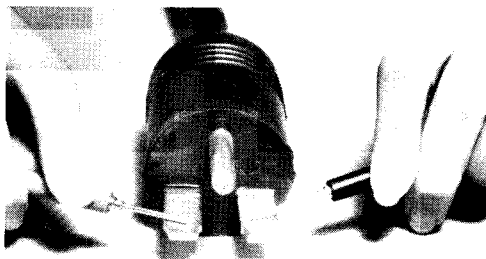

\* An element tester cannot be used to test a kiln for a short between two hot wires; a multimeter is necessary to perform this test.

**f. Compare ohm reading with chart (see 2.11) to establish correct resistance for your particular kiln.**

- 1) If ohms are considerably less than they should be or zero, there is a short circuit to be corrected (see 2.8).
- 2) If ohms are considerably higher than they should be, there is an open circuit in at least one section of kiln.
- 3) If multimeter's needle does not move, either
  - a) An open circuit exists (see 2.8), or
  - b) Kiln-sitter was not activated.

**g. If ohm reading does not match chart, to isolate problem (in any Duncan kiln with more than one switch):**

- 1) Turn all switches off.
- 2) Turn on one switch at a time.
- 3) Place one probe on each hot blade of plug.
- 4) Compare ohm reading with chart (see 2.11) to establish correct resistance for kiln section.
- 5) If readings do not match, review **step f** for possible causes.

## Testing Safety Timer Motor

Frequently, the reason a safety timer malfunctions is a loose connection (see 8.2). If this is not the problem, the following tests will help pinpoint the reason.

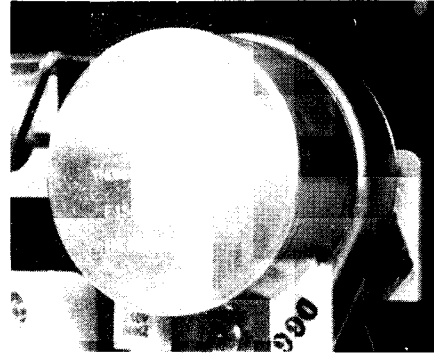

### 1. Testing for Continuity

- a. *Unplug kiln.*
- b. **Remove control panel (see 4.1).**
- c. **Set multimeter for ohm-scale reading (see 2.6).**
- d. **Turn all switches off.**
- e. **Place test probes on two top screws of kiln-sitter switch block.**
  - 1) Meter reading should be **between 2,000 and 10,000 ohms.**
  - 2) If ohms are considerably less, a short circuit exists; replace motor.
  - 3) If there is no needle movement, an open circuit exists; replace motor.
- f. **Reposition control panel on kiln (see 4.2 for detailed instructions).**

### 2. Testing Gears

If ohm reading was correct yet timer still does not seem to function, gears may be jammed.

- a. **Plug kiln in.**
- b. **Activate kiln-sitter.**
- c. **Set timer for one hour.**
- d. **Note actual time of day.**
- e. **Check timer one hour later.**
  - 1) If timer has moved to zero, timer gears are working.
  - 2) If timer is still where originally placed, gears are jammed; replace motor.

## Predelivery Test

There is nothing quite so embarrassing as having a customer take a repaired kiln home and find out it does not work. To protect yourself and to assure customer satisfaction, make it a standard practice to plug in every kiln before it leaves the shop to be certain all sections heat. This is just one more way of assuring your customers that they are getting the full attention they deserve.

This test is not a substitute for the tests for electrical soundness (see 2.8 - 2.10) which should also be performed before returning a kiln to a customer.

## Normal Ohm Readings Chart

Most multimeters are not accurate enough to give exact readings to a tenth of an ohm. Therefore, the readings you obtain with your particular meter may vary slightly from those listed.

MODEL ES or DK	OHMS		
	PER ELEMENT	PER SECTION	PER KILN
716-1 716-2	2.5	-	15.2
716-3 716-4	2.1	-	13.0
820-1 820-2	4.6	18.8	9.4
820-3 820-4	4.0	16.3	8.2
820X-1 820X-2	4.6	18.8	9.4
820X-3 820X-4	4.0	16.3	8.2
DK 829-1 DK 829-2	4.6	18.8	6.3
DK 829-3 DK 829-4	4.0	16.3	5.4
1020-1 1020-2	3.7	15.0	7.5
1020-3 1020-4	3.2	13.0	6.5
1029-1 1029-2	3.7	15.0	5.0
1029-3 1029-4	3.2	13.0	4.3

# ELECTRICAL SERVICE

## POWER SUPPLIES

The Duncan kiln with model numbers ending in -1 and -2 are designed to operate on a 240-volt supply, while the -3 and -4 models are for 208-volt supplies.

It is important that, before selling a kiln, you determine from your customer which voltage he has. If in doubt, the customer should contact his local power company for the information. A word of caution! Since some major appliances will operate equally well on either 208- or 240-volt supplies, many electricians when merely asked "Do I have 240 volts?" will say, "Yes," thinking it does not matter. It is much safer to phrase the question, "Do I have 240 or 208 voltage?"

The places where 120/208-volt power supplies are most likely to occur are schools, hospitals and new shopping centers where there is heavy usage of light fixtures and other 120-volt loads.

If a customer has a different voltage than his kiln is designed for, it will not operate properly. A 240-volt kiln will low-fire on a 208-volt supply, however, it will take an excessively long time to fire. A 208-volt kiln should never be used on a 240-volt supply as it would draw too much current, causing premature failure of the elements, switches, cord, etc.

### Low-Voltage Supply

If a new kiln is taking excessively long to fire and all its components are working correctly, the voltage the kiln is receiving may not be sufficient. The two most usual causes are that the transformer serving the building is not supplying enough voltage or the customer is firing at a peak period when there is excessive drain on the electric power in the area. If you suspect low voltage, have your customer contact his power company and request that a voltmeter be placed on his line. Usually, there is no charge for this service. The meter will make a continual record of the voltage coming into the building; usually the recording will cover several days. If the voltage is found to be below standard (in most states, this is 240 volts plus or minus 5%), the power company may install a booster or new transformer. If the voltage drop is only during peak periods, your customer should, if possible, arrange to fire at a different time of day.

### Three-Phase Supply

An electrician can install a single-phase Duncan kiln on a three-phase circuit by using only two hot legs from the circuit when connecting the kiln's wall receptacle. If more than one kiln is being wired to a three-phase supply, they should be connected to different hot legs to balance the load.



# CONTROL PANEL

The control panel on a Duncan kiln houses the kiln's electrical components. It serves as the mounting surface for switches, kiln-sitter, etc., and its design also allows all controls to be together and in front for easy visibility, operation and repair.

There is ample space inside the control panel to prevent the electrical connections from touching each other. This, of course, is important as it helps prevent possible short circuits in the wiring which can be caused by wires touching when they should not, as well as by wires or connectors with deteriorated or burned spots, loose connections or miswiring. Therefore, it is recommended that every time a control panel is removed, the wiring be carefully inspected. When replacing a control panel, all wires should be pressed toward the front of the panel to prevent contact with the heat shield or any other parts.

Since heat is the number-one enemy of electrical parts, care was taken to incorporate as many temperature-reducing features as possible into the control panel design. The louvers in the control panel allow air circulation inside the panel and the standoffs minimize direct heat transfer from the kiln case to the control panel.

The heat shield, as its name implies, protects the control panel from the heat radiated by the kiln. It creates a narrow, vertical, open-ended passageway which allows cool air to be drawn in at the bottom and hot air to escape out the top in a chimney effect. The heat shield is held rigidly in place by the insulators, bus bars and U-terminals; the one-inch hex head sheet metal screw in the lower left corner ensures proper grounding.

## REMOVAL

1. *Unplug kiln.*
2. **If kiln has collar:**
  - a. Remove screws on each hinge that connects collar to kiln.
  - b. Lift collar to disengage interconnect and turn unit so interconnect remains separated.
3. **Remove lid-venting prop and control panel's mounting screws.**
4. **Carefully pull control panel off kiln until kiln-sitter tube is free; keep tube level so it will not gouge brick.**
5. **Disconnect wires attached to two lower switch terminals on each switch to free control panel.**
6. **Whenever control panel is removed, for any reason, it is advisable to check:**
  - a. All wiring for deterioration, burned spots, loose connections or other defects.
  - b. Cord for frayed wires and any contact between lead wires.

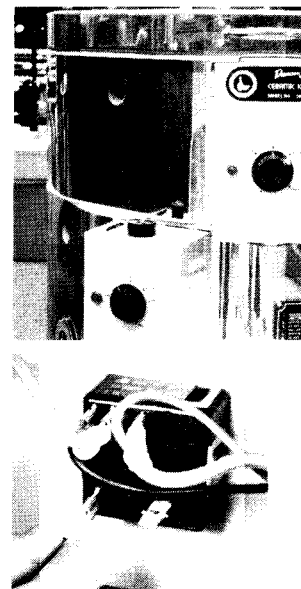

# CONTROL PANEL REPLACEMENT

4

1. **Connect wires from elements to switches. Two top wires go to top switch, etc. (see appropriate Electrical Schematic, Appendices B, D or F).**
  - a. Slip-on terminals should fit tight when pushed onto switch tabs; they should not slip off and on easily.
  - b. If terminal is loose, tighten by gently squeezing terminal with pliers.
2. **Carefully reposition control panel onto kiln.**
  - a. Route wire from lowest U-terminal connector to left of kiln-sitter tube as you face kiln.
  - b. Press all wires to front of panel so they will not touch heat shield, kiln-sitter tube, or be pierced by the ends of the elements.
3. **Replace mounting screws.**

When replacing collar control panel:

- a. Loosely replace mounting screws.
- b. Return collar to proper position.
- c. Slide control panel down so that interconnect plug is inserted as far as possible into interconnect receptacle.
- d. Firmly tighten screws.
- e. Replace four hinge screws.

4. **Replace lid-venting prop.**
5. **Test kiln with multimeter for electrical soundness (see 2.8 - 2.10).**
6. **Check kiln-sitter adjustment (see 8.1 - 8.2) before test-firing kiln.**

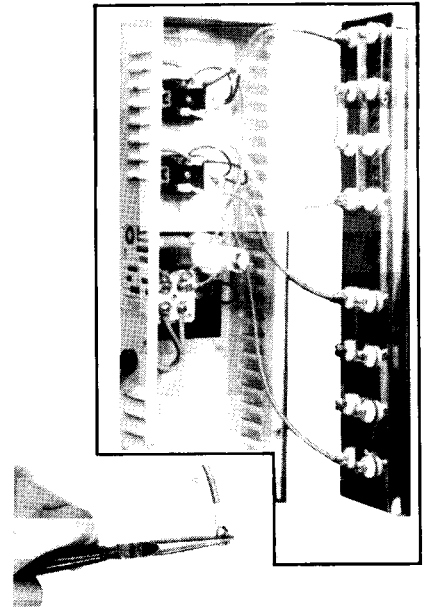

# BUS BARS, U-TERMINALS AND INSULATORS

Duncan kilns use both bus bars and U-terminals as element connectors. Both are made of brass, an excellent conductor, and plated with nickel to prevent heat corrosion and to prolong life. Bus bars have been used in the electrical field for many years but are somewhat uncommon in the kiln industry. They were a natural for the Duncan kiln because of the number of elements to be joined, the short distance between elements, their ability to carry current, and their rigidity which provides a very mechanically secure joint. Both bus bars and U-terminals are available in bulk or as complete connector assemblies. A connector assembly consists of a bus bar or U-terminal, a terminal clamp and hex nut (see Appendix A for correct order numbers).

Insulators prevent contact between the current-carrying element and the heat shield. Their flanged design permits them to fit snugly over the holes in the heat shield, thereby preventing the heat from flowing directly into the control panel as well as eliminating the possibility of a short. It is important that the insulator's flange fits tightly against the heat shield or its thermal insulation value will be lost.

Whenever it becomes necessary to replace an insulator, an element or any part of a connector assembly, all the other components mentioned should be inspected carefully. The same condition that caused one component to fail can affect the others.

It is very uncommon for an insulator to crack, but in the event one does, it should be replaced immediately.

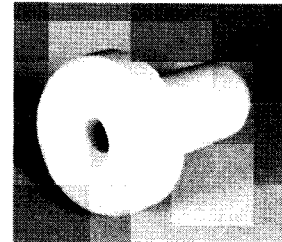
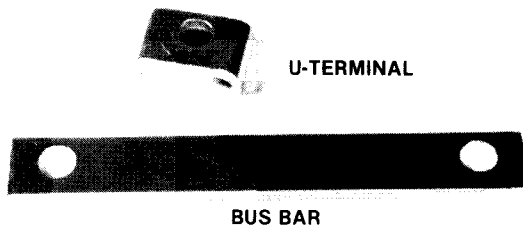

## REPLACEMENT

1. *Unplug kiln.*
2. **Remove control panel (see 4.1).**
3. **Loosen and remove appropriate connector assembly.**
  - a. Use screwdriver and 3/8" hex nutdriver or small crescent wrench.
  - b. It is not necessary to disassemble connector.
4. **When replacing an insulator:**
  - a. Compress element end with a pair of pliers and twist off damaged insulator. *Elements are brittle after firing and will break easily. Use care, even when working with element ends.*
  - b. Twist on new insulator, then spread element ends with pliers, as shown.

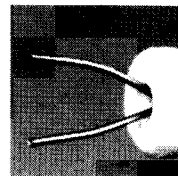

**5. When replacing bus bar or U-terminal:**

- a. Loosely assemble new unit, as shown.
- b. Use connecting wire from old U-terminal assembly, if it is not damaged.



**6. Place bus bar or U-terminal assembly onto element.**

- a. Slip element ends between terminal clamp and U-terminal or bus bar so clamp's curved edges form a vise around element.
- b. Since holes in U-terminals and bus bars are not centered, place widest part toward insulator.

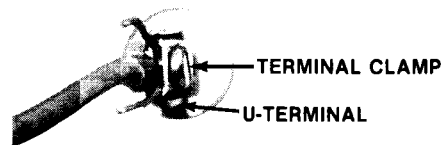

**7. Firmly tighten connection. (The tighter, the better.)**

- a. Insulator should be snug against heat shield.
- b. Element end should be pulled toward you to take up any slack.

**8. Cut off any excess element wire close to connectors.**

**9. Connect wires from elements to switches and reposition control panel on kiln (see 4.2 for detailed instructions).**

**10. Test kiln with multimeter for electrical soundness (see 2.8 - 2.10).**

**11. Check kiln-sitter adjustment (see 8.1 - 8.2) before test-firing kiln.**

# INFINITE SWITCHES

Duncan kilns have infinite switches, which allow the user to select the amount of heat to be produced by the elements. This type of switch is used in hundreds of different appliances and has proved to be extremely reliable due to its simple design and unique operating principle. When replacing an infinite switch, remember that these switches are differentiated for 240-volt and 208-volt models and the correct switch must be used.

## HOW THE SWITCH WORKS

Technically, an infinite switch is a bimetal input regulator. It operates on somewhat the same principle as a thermostat. Whenever the switch is turned on, it closes a contact within the switch which completes the circuit, thereby sending power to the elements and the bimetallic control strip. It is the bimetallic strip, consisting of two metals (phosphor and bronze) which have different rates of expansion and contraction, that causes the switch to cycle. As the strip becomes sufficiently heated, it will bend and open the contact points so current ceases to flow through the switch. This action causes the elements to stop heating. As the strip cools, it relaxes enough that the pull from the magnet positioned opposite the strip comes into play with a snap action and the contacts close. This reenergizes the elements and the bimetallic strip, causing the cycle to repeat.

## CYCLING

When not in the **OFF** position, the switch automatically cycles on and off, thereby regulating the power input to the elements. While cycling, the switch will produce a soft, intermittent clicking sound as the contacts within each switch open and close.

It is unusual for a switch to be noticeably out of calibration (cycling improperly), although occasionally this will happen. A severely miscalibrated switch (slight variances are all right) usually would cause the kiln to fire so unevenly that it would be difficult to correct the unevenness by changing the switch settings (see 6.3).

There are three checkpoints where a switch can be readily checked for proper cycling. At the checkpoint to the left of **OFF** (you can feel it click in), the switch should be on between 20% and 35% of the time. As the switch knob is turned counterclockwise, the percentage of time the switch is on gradually increases, thereby gradually increasing the amount of heat produced by the elements.

The most accurate checkpoint is opposite the **OFF** position. In other words, turn the dial so the indicating arrow is pointing straight down. This checkpoint will be more representative of the calibration of the switch over its entire operating range. At this position, the switch should be on between 50% and 64% of the time.

When the switch is turned counterclockwise to the third checkpoint **HI-FIRE** (to the right of **OFF**), the switch is completely on or noncycling, thus delivering full continuous power to the elements.

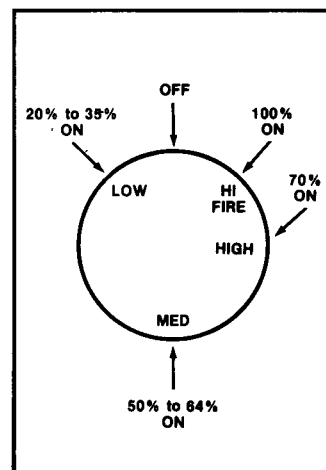

The voltage available to the kiln will affect switch calibration. Our instructions assume the kiln is receiving a full 240 or 208 volts. If the actual voltage received is more than your kiln's designated requirement, the amount of on time will fall below the minimum acceptable percentage, yet the switch would not be out of calibration, just reacting to the voltage supply. Low voltage will affect switch calibration in just the opposite manner: there will be more on time than normally acceptable. Therefore, if the switch is slightly out of the recommended range, it may be due to a voltage variation and not a miscalibrated switch.

Only in a very few situations will a switch's calibration affect the firing of a kiln and then the usual result would be an uneven firing.

## Checking Switch Calibration

1. Turn switch to position opposite **OFF** (arrow pointing straight down).
2. Let switch cycle at least twice (to let switch warm up and stabilize).
3. Time cycle with watch or clock that has a second hand.
  - a. Time period of cycle during which power is being received by elements. Usually a slight hum from elements can be detected during this period, plus there is a click at the beginning and end as contacts open and close. (Example: This period might be 11 seconds.)
  - b. Time quiet period when there is no humming of elements. (Example: This might be 9 seconds.)
  - c. Total both periods for full cycle time. (Example: 11 seconds on plus 9 seconds off, equals 20 seconds for full cycle.)
4. Compute percentage of time switch cycled on by dividing amount of time on by total cycle time. (Example: 11 seconds divided by 20 seconds, or 55%.)
5. Check resulting percentage to be sure it is in the acceptable range: 50% to 64%. It is best to time the switch two or three times and take the average results.

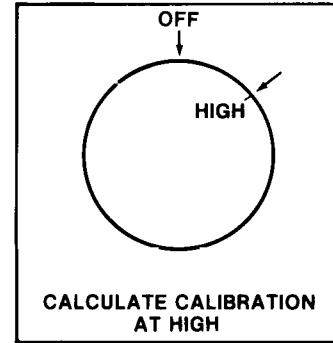

## Correcting Switch Calibration

If the switch calibration is too low, it can be corrected by using a kiln-sitter screwdriver to twist the small screw at the bottom of the switch a half turn counterclockwise. To make this adjustment, the switch should be removed from the control panel. Replace the switch according to instructions (see 6.4). The switch should then be turned on and retimed to be sure of calibration.

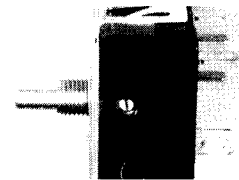

If the switch is calibrated too high, resulting in it being on substantially more than 64% of the time (perhaps even continually on) at the checkpoint opposite the **OFF** position, you may be able to correct it by turning the screw at the bottom of the switch a half turn or more clockwise. However, it is possible that if a switch is cycling on too much this adjustment will not correct the problem and the switch will have to be replaced.

## CHANGING SWITCH SETTINGS

The switch settings for each model were established after extensive testing to ensure even-firing results. However, there are situations when altering the switch settings from the factory markings can be beneficial.

The switch settings can be either increased or decreased, depending on whether the need is for more heat or less heat within a certain section of the kiln. Whatever the need, altering the switch settings is a matter of trial and error.

When a setting is altered, make a mark with a pencil on the control panel indicating the new position(s). Test-fire the kiln with the altered settings, using witness cones at all levels. After the kiln has cooled, check the witness cones carefully and, if necessary, make another adjustment. It may take several alterations to get the kiln firing to your satisfaction.

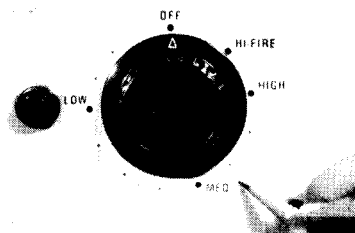

## Slow-Firing Kiln

Occasionally, you may receive a complaint of a kiln firing too slowly. This can be frustrating not only because there are very legitimate causes but also because it is difficult to define when a firing is **too** long. What might be a standard firing time for one customer may be much too long for another.

The electrical and mechanical reasons for a slow-firing kiln are listed in the Troubleshooting Chart (see 2.1 - 2.2).

If the problem is neither electrical nor mechanical, there are still ways to shorten a kiln's firing time. One method would be to advance the **MED** and **HIGH** heat settings slightly. A less desirable solution would be to shorten the recommended Duncan firing schedule, if this has not already been done. The first few firings with a shortened schedule should be carefully controlled with witness cones at all levels to ensure ware maturity. For DK's, be extremely cautious about shortening the venting period. This step is critical to allow gases and fumes to escape.

## Uneven-Firing Kiln

An uneven firing in a Duncan kiln is usually correctable by adjusting switch settings. There is no need to live with hot or cool spots! If witness cones indicate that a particular area is continually hotter or cooler than the rest of the kiln, the switch that controls the elements for that area of the kiln can be altered so that more or less heat is produced in the area. A change in setting may be required at each switch position (with the exception of **HI-FIRE**) or at only one position (generally **HIGH**). Witness cones should be placed at all levels to check your results.

## SWITCH "POPPING"

One peculiarity associated with the infinite switch is a "popping" noise heard periodically when the switch is on. This is caused by dust getting on the internal contacts, which creates a small arc when the contacts open. Popping will usually occur more often if the kiln is in a dusty location. It is not a cause for alarm, as it will not harm the switch or the kiln.

## PILOT LIGHT

When the switch is out of the **OFF** position, the pilot light is on continuously, indicating that there is power going through the switch. If the switch is on but the pilot light is out, do not initially assume a defective pilot light unless the kiln is heating properly. These are neon lights and are extremely reliable and long lasting. Usually a nonlighting pilot light indicates a faulty connection or switch (see 2.3).

# SWITCH REPLACEMENT

1. *Unplug kiln.*
2. **Pull knob off switch.** If necessary, pry off with screwdriver.
3. **Remove control panel** (see 4.1).
4. **Disconnect all wires connected to switch being replaced.**
5. **Free switch from control panel by removing pal nut with crescent wrench.**
6. **Position new switch in control panel right side up and so its nubs fit into locator holes.**
7. **Screw pal nut onto switch shaft and tighten firmly.**
8. **Reconnect wires to switch as follows:**
  - a. To tab P attach single wire from pilot light.
  - b. To tab L<sub>1</sub> attach wire from left kiln-sitter contact as you face inside of control panel. When working on collar, this is the wire connected to left terminal screw of interconnect plug.
  - c. To tab L<sub>2</sub> attach wire from right kiln-sitter contact; this wire has the other pilot light wire attached. When working on collar, this is the wire connected to right terminal screw of interconnect plug.
9. **Connect wires from elements to switches and reposition control panel on kiln** (see 4.2 for detailed instructions).
10. **Replace switch knob.** If knob fits loosely, use screwdriver to slightly spread slot in switch shaft.
11. **Test kiln with multimeter for electrical soundness** (see 2.8 - 2.10).
12. **Check kiln-sitter adjustment** (see 8.1 - 8.2) before test-firing kiln.

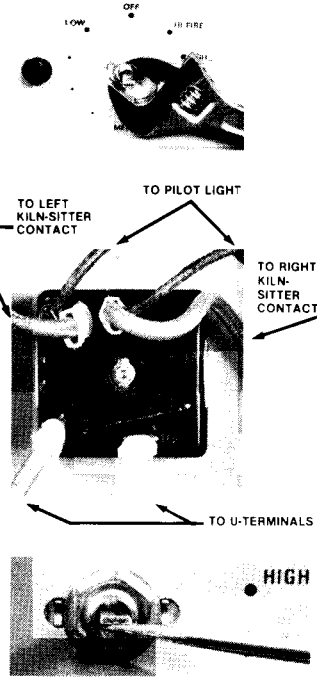

6



# ELEMENTS

The most vital part of an electric kiln is its elements because they produce the heat. A kiln element is a conductor that has sufficient resistance to safely change large amounts of electrical energy into heat energy. The amount of heat an element will produce is inversely related to the amount of resistance in the element. This resistance will vary according to the wire's length, diameter and composition. Resistance is measured in ohms. The optimum ohms for a new element for each Duncan kiln model is listed on the chart on 2.11; instructions on how to use a multimeter to locate a weak or damaged element are given on 2.7.

All Duncan elements are manufactured of a high-quality iron-chromium-aluminum alloy (commonly called resistance wire) which can be heated to 2505° F. Care is taken in manufacturing these elements so that potential life-shortening factors are minimized. Elements are wound on a precision machine, designed specifically for coil winding, so every element is consistent in coil length, diameter and spacing, thus providing uniform heating. This machine also prevents scratching and gouging of the resistance wire which would severely shorten the life of an element.

After winding, a portion of the element's ends are twisted double, halving the resistance, thus less heat is produced by this portion which extends into the control panel where heat is not desirable. Just beyond the twisted area, the element end is split into two separate wires, which provide two points of contact and a very secure connection when the elements are connected to the bus bars and U-terminals.

The elements are then given a hot bath to be sure that no traces of lubricants, which would reduce element life, remain on them. After the elements are dried they are stretched and bent to fit each kiln.

Individual replacement elements for each kiln model are available and prepackaged with complete installation instructions. Be careful not to install 240-volt elements in a 208-volt kiln or vice versa.

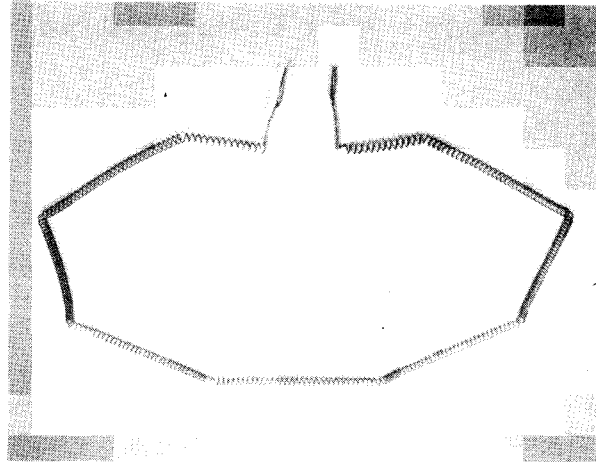

## MAINTAINING ELEMENT LIFE

A thin protective coating of greyish-white alumina will form on the surface of iron-chromium-aluminum elements when fired in a pure oxidizing atmosphere above 1800° F. (the recommended cone 05 break-in firing, see *Owner's Manual*, page 14). This layer of alumina is an oxide which is produced when oxygen in the air combines with the aluminum in the element and is very important in prolonging the life of an element. It retards further oxidation of the element and provides protection against attack from gases and fumes which are released from clay and glazes during firing. Gradually, within the normal life of an element, the oxide coating will be destroyed and replenished until the aluminum content is reduced to practically nothing. Then iron-chromium oxide will form. The presence of this greyish-black oxide is a good indication that the element is nearly worn out.

Although it is difficult to generalize about the probable life of elements, they should last for many, many firings providing no accident occurs within the kiln. High-fire temperatures (porcelain and stoneware), however, will shorten the life of a kiln's elements at a faster rate. Those ceramists who fire their kiln on a daily basis to cone 6 or cone 8 will need to replace elements much more often than the ceramist doing daily cone 05 firings. If a Duncan element fails prematurely, it can usually be attributed to one of the following causes.

**Insufficient oxide coating on elements.** This is, generally, the result of failing to do the initial cone 05 break-in firing which allows the protective alumina coating to form on new elements. Many new kiln owners, not understanding the importance of this process and being anxious to fire their pieces, do this firing with a load of ware.

**Glaze or kiln wash on elements.** If even a small spot of glaze or kiln wash touches an element, it will destroy the oxide coating at its point of contact and ruin the element. Glaze and kiln wash on wall brick can "creep" to a nearby element quite easily during firing, causing failure.

**Reduction firings.** An electric kiln is not recommended for reduction firings. As previously mentioned, the protective coating of alumina on the elements is essential for long element life and a reducing atmosphere would cause the coating to be destroyed, thus greatly decreasing element life. Many authorities state that the coating may be restored if an oxidation firing (the standard cone 04-05 bisque firing) is done between reduction firings. Although this is true, it does cause the aluminum content of the element to be used up much faster, greatly reducing the element's life.

# 7

## ELEMENT REPLACEMENT

1. **Unplug kiln.**
2. **Remove control panel (see 4.1).**
3. **Locate damaged element with element tester or multimeter (see 2.7).**
4. **Loosen and remove appropriate connector assemblies.**
  - a. Use screwdriver and 3/8" hex nutdriver or small crescent wrench.
  - b. It is not necessary to disassemble connector.
5. **Compress each element end with a pair of pliers or cut them off and remove insulators.**
6. **Use needle-nose pliers to remove old element.**
  - a. Carefully pull both ends of element out of terminal brick.
  - b. Gently lift element up and out of groove and free of element slot.
  - c. *Do not leave any pieces of old element in groove.*
7. **Install new element.**
  - a. Insert one end of new element through terminal brick. Use needle-nose pliers to help push it through.
  - b. Feed element into slot.
    - 1) Make sure each preformed bend fits snugly into a corner with no tension on groove's lip.
    - 2) If necessary, compress element as you work around kiln.
  - c. Before feeding element into last two bricks, insert loose end through terminal brick.
  - d. Use table knife or closed needle-nose pliers to gently press element down into groove.
    - 1) Work systematically around kiln, pressing element down every two or three inches.
    - 2) Be especially careful at corners as bricks chip easily.



8. **Replace insulators.**
9. **Cut loop off element and spread wires with pliers.**
10. **Replace connectors (U-terminal or bus bar) onto element.**
  - a. Slip element ends between terminal clamp and U-terminal or bus bar so clamp's curved edges form vise around element.
  - b. Since holes in bus bar and U-terminal are not centered, place widest part toward insulators.
11. **Firmly tighten connections. (The tighter, the better.)**
  - a. Insulators should be snug against heat shield.
  - b. Element ends should be pulled toward you to take up any slack.
12. **Cut off excess element wire close to connectors.**
13. **Connect wires from elements to switches and reposition control panel on kiln (see 4.2 for detailed instructions).**
14. **Test kiln with multimeter for electrical soundness (see 2.8 - 2.10).**
15. **Vacuum kiln, removing all brick chips lodged in element groove.**
16. **Check kiln-sitter adjustment (see 8.1 - 8.2).**
17. **Test-fire kiln to cone 05, empty except for three evenly spaced shelves with witness cones on each, to:**
  - a. Allow protective oxide coating to form on new elements.
  - b. Check for evenness of firing, so adjustment of heat settings can be made, if necessary (see 6.3).



TERMINAL CLAMP  
U-TERMINAL

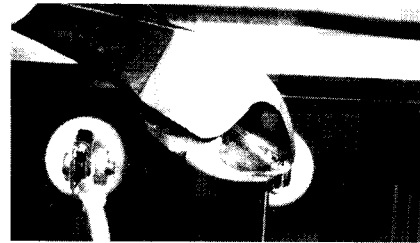

## ELEMENT STAPLES

When a brick is so badly damaged that the element is no longer supported, it is almost impossible to repair. Often brick replacement can be postponed by fastening the element to the brick with Duncan Element Staples. Both elements and element staples are made of the same resistance wire. Do not use staples or pins of any other material as they will damage the elements.

Once an element is fired, it becomes extremely brittle when cool. If an element that has been fired sags out of the brick groove, do the following:

1. **Heat element to soften it.**
  - a. With lid open, turn appropriate switch to **HI-FIRE** until elements glow dull red, then turn kiln off and *unplug it*; or
  - b. *Unplug kiln* and, with a propane torch, heat portion of element that will be disturbed.
2. **Insert element staples.**
  - a. Use needle-nose pliers to insert staple every few inches to secure element to kiln brick.
  - b. Be sure element wire is actually caught between two prongs of staple.
  - c. *Do not allow staple to penetrate through brick and touch kiln case as this could cause a short circuit.*

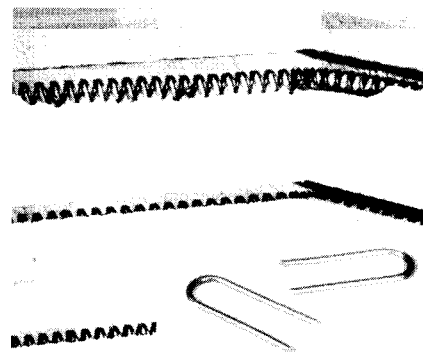

An element that has never been fired is quite flexible and heating to soften is not necessary. Merely insert a staple every few inches as outlined above.

# DAWSON KILN-SITTER

Every part in a kiln-sitter can be replaced individually, however, Duncan stocks only a few commonly needed kiln-sitter parts. Any other part needed can be obtained from the manufacturer, W.P. Dawson, Inc., 1147 East Elm, Fullerton, California 92631, telephone (714) 525-7713.

Like all progressive manufacturers, Dawson makes improvements on their products whenever possible. Only very rarely do these improvements involve major revisions requiring model number changes as happened in late 1976.

When kiln-sitter model K was replaced by model K-10 and limit timer model LT-3K by LT-4K, it was due to the development of a new claw, eliminating the need for a claw adjustment. Duncan DK 820 kilns with serial numbers between A01011 - A01448 and A01500 - A01806 are equipped with the early series kiln-sitters, models K and LT-3K.

On both the current series models and a few of the late model K and LT-3K, you may find a counterweight installed on the sensing rod; this should be removed. The counterweight was installed to standardize the amount of weight placed on the kiln-sitter cone; however, with use, the sensing rod deteriorates, so less and less weight is placed on the cone. By removing the counterweight, more weight is placed on the kiln-sitter cone and the chance of a possible overfire is reduced.



EARLY SERIES



CURRENT SERIES

## MAINTENANCE PROCEDURES

1. *Never use lubricants of any kind.*
2. **Check kiln-sitter adjustment frequently.** Heat, corrosion and mechanical wear can cause the kiln-sitter to slip out of adjustment after a period of use.
  - a. **Turn off all switches.**
  - b. **Install firing gauge, as shown.**

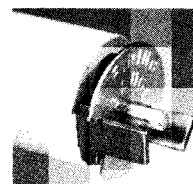

**c. Check position of trigger.**

- 1) Raise weight up against guide plate, then slowly swing it forward; trigger should just clear tip of claw.
- 2) Set-screw in front of weight may be loosened to raise or lower trigger; retighten firmly after adjustment.

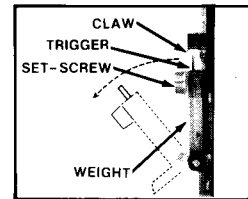

On early series models K and LT-3K, it is necessary to check the claw position as follows:

- 1) Install firing gauge.
- 2) Raise weight up against guide plate.
- 3) Pull claw forward until slight play in swivel assembly can no longer be felt.
- 4) Check for a 1/16-inch clearance between inside of claw and trigger.
- 5) Loosen set-screw on top of claw if adjustment is necessary; retighten firmly.



**d. Check travel of sensing rod.**

- 1) Remove firing gauge.
- 2) Hold small mirror inside kiln so you can see path of sensing rod.
- 3) Press down on claw and check movement of rod within tube cavity; it should not touch sides at any point.
- 4) Center sensing rod by loosening guide plate screws and moving guide plate to right or left; retighten screw firmly.

**3. Pull sensing rod out of tube and check its appearance frequently.** Replace any rod displaying any of the following conditions as they could cause a kiln to underfire or overfire.

- a. Deterioration of end of rod extending into kiln.
- b. Bent or warped sensing rod.
- c. Rod accumulating a buildup of rust at pivot point about 2-1/8 inches from claw end of rod (see 8.5).

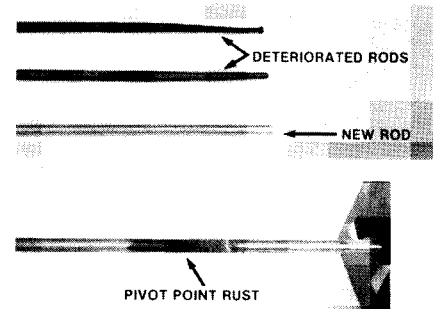

**4. Check appearance of cone supports.**

- a. Deteriorated or warped cone supports should be replaced as they can cause a kiln to underfire or overfire even when all other adjustments are correct.
- b. A buildup of kiln wash on cone supports, or none at all, can cause a kiln-sitter to overfire. Generally, kiln wash can be scraped off quite easily; however, if nonremovable materials accumulate, replace the cone supports.

## REPAIRS

The most common kiln-sitter repairs will be replacement of the sensing rod or tube assembly. Complete instructions for each of these operations are given in this section. Other mechanical malfunctions can usually be traced by following the appropriate kiln-sitter diagram (see Appendices H or I).

There are only four parts for the early series models K and LT-3K — the tube assembly, claw, claw set-screw, and the front plate — which cannot be replaced with parts intended for the current models. Check the parts list (Appendix I) for the correct part number and order these parts from W. P. Dawson.

Occasionally, a safety timer may not operate. This is usually the result of a loose lead wire, a malfunction, or jammed gears in the motor. If you experience such a problem, first be certain it is not the result of a loose wire. Check that the ends of the wires coming from the timer motor are not loose or disconnected and that the ends connected to the kiln-sitter are held tightly. If all connections are secure, test timer motor following instructions on 2.10.

## Sensing Rod Replacement

1. *Unplug kiln.*
2. **Remove old sensing rod.**
  - a. Remove screws holding guide plate.
  - b. If rod has not been distorted:
    - 1) Withdraw rod from tube with guide plate and claw attached.
    - 2) Remove claw and guide plate from rod.
  - c. If rod has been distorted:
    - 1) Unscrew claw set-screw.
    - 2) Remove claw and guide plate from rod.
    - 3) Withdraw rod from inside of kiln.
3. **Install new sensing rod.**
  - a. Make sure inside of tube is clean before installing new rod.
  - b. Slide claw onto new rod and tighten claw set-screw. If a counterweight is available, do not use (see 8.1 for explanation).
  - c. If claw has slipped out of guide plate:
    - 1) Insert rod and claw into top of guide plate slot from front.
    - 2) With a claw peg in front of guide plate and one behind it, lower claw halfway down slot.
  - d. Holding assembly (guide plate, claw and sensing rod) as shown, slide sensing rod into tube.
  - e. Position guide plate on front plate and replace screws. Claw is now free to move up and down in slot but is restrained from moving in and out by the pegs.
4. **End of sensing rod should be even with ends of cone supports.** If adjustment is necessary, loosen set-screw in claw, then retighten firmly.
5. **Check kiln-sitter adjustment (see 8.1 - 8.2) before doing a cone 020 test-firing (see *Owner's Manual*, page 14).**

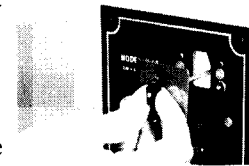

8

### Early Series Models K and LT-3K, Sensing Rod Replacement

1. *Unplug kiln.*
2. Remove control panel (see 4.1).
3. Remove tube assembly.
  - a. Remove screws holding guide plate.
  - b. Free tube from front plate by removing flat headed screws located behind guide plate.
4. Remove old sensing rod.
  - a. Remove claw set-screw.
  - b. Loosen set-screw in swivel assembly.
  - c. Withdraw rod from tube.
5. Install new sensing rod.
  - a. Insert new rod into tube.
  - b. With end of rod even with ends of cone supports, firmly tighten set-screw in swivel assembly.
  - c. If old rod has a counterweight, do not use (see 8.1 for explanation).
6. Attach tube assembly, positioning it so cone support slots point down.
7. Place claw on end of rod and firmly tighten set-screw.
8. Replace guide plate.



(continued on next page)

9. Connect wires from elements to switches and reposition control panel on kiln (see 4.2 for detailed instructions).
10. Test kiln with multimeter for electrical soundness (see 2.8 - 2.10).
11. Check kiln-sitter adjustment (see 8.1 - 8.2) before doing a cone 020 test-firing (see *Owner's Manual*, page 14).

## Tube Assembly Replacement

1. **Unplug kiln.**
2. **Remove control panel (see 4.1).**
3. **Remove tube assembly.**
  - a. Remove screws holding guide plate.
  - b. Unscrew claw set-screw.
  - c. Remove claw and guide plate from rod.
  - d. Free tube from front plate by removing flat headed screws located behind guide plate.

For early series models K and LT-3K, only tube assembly #70 will fit these units; order it from Dawson and be sure to specify the long tube.

3. **Remove old tube assembly.**
  - a. Remove screws holding guide plate.
  - b. Free tube from front plate by removing flat headed screws located behind guide plate.
  - c. Remove claw from sensing rod.

4. **Attach new tube assembly, positioning it so cone support slots point down.**



For early series models K and LT-3K:

- a. If a counterweight is available, do not use (see 8.1 for explanation).
- b. Place claw on end of new rod and firmly tighten set-screw.
- c. Replace guide plate and proceed with **step 10** below.

5. **Slip sensing rod out of tube assembly.**
6. **Slide claw onto rod and tighten claw set-screw. If a counterweight is available, do not use (see 8.1 for explanation).**
7. **If claw has slipped out of guide plate:**
  - a. Insert claw into top of guide plate slot from front.
  - b. With a claw peg in front of guide plate and one behind it, lower claw halfway down slot.
8. **Holding assembly (guide plate, claw and sensing rod) as shown, slide sensing rod into tube.**
9. **Position guide plate on front and replace screws.**
10. **End of sensing rod should be even with ends of cone supports.** If adjustment is necessary, loosen set-screw; retighten firmly.
11. **Connect wires from elements to switches and reposition control panel on kiln (see 4.2 for detailed instructions).**
12. **Test kiln with multimeter for electrical soundness (see 2.8 - 2.10).**
13. **Check kiln-sitter adjustment (see 8.1 - 8.2) before doing a cone 020 test-firing (see *Owner's Manual*, page 14).**

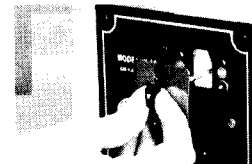

# SPECIAL SITUATIONS, MODELS K-10 AND LT-4K

During the first two production years of Duncan kilns, there were two separate problems with Dawson kiln-sitter models K-10 and LT-4K. Although resolved, they may occasionally reoccur because, if a kiln was operating properly and no overfiring occurred, the corrective steps may not have been taken.

## Narrow Guide Plate Slot

A number of guide plates installed on kilns using Dawson kiln-sitters had a vertical slot which was too narrow to allow the claw to move freely within the slot during firing. A few of these also had a small burr on one side of the slot which further hampered movement. When a kiln is cool, the narrow guide plate slot is not readily apparent, but when a kiln is heated the slight expansion of these parts prevents the claw from sliding down when the cone bends, thus causing the kiln to overfire.

This problem affected all kiln companies that used Dawson kiln-sitters and Dawson quickly corrected the problem by sending the manufacturers new guide plates. All Duncan kiln distributors were notified by telephone and were requested to change all guide plates on kilns within the serial number listed. These Duncan kilns were manufactured between July 1 and October 26, 1976.

DK 716-1	A03051 - A04428	DK 820-1	A04562 - A04788
DK 716-2	A04451 - A04484	DK 820-2	A04665 - A05248
DK 1020-1	A03084 - A03217	DK 1029-1	A03580 - A03961
DK 1020-2	A03382 - A03567	DK 1029-2	A04084 - A05597

It is possible, however, that a narrow guide plate may still be found. To determine if a particular guide plate slot is narrow, you can use the following tests.

1. Take the claw between your thumb and forefinger and twist it slightly; there should be room for some flexing. Because this is a very subjective judgement, you should compare the amount of flexing the claw will do in a good guide plate; **or**
  2. Try to slip two or three pieces of standard bond typing paper between the claw and the edge of the slot. If you can only get one piece in, the guide plate slot is probably too narrow; **or**
  3. Use a dial caliper to measure the slot's width. It should be at least .198 inches wide.
- If you discover a narrow guide plate, replace it.

## Rust on Sensing Rod at Pivot Point

The Dawson tube assembly used in Duncan kilns, as well as in several competitive kiln brands, prior to May 4, 1977, has a tendency to form a buildup of rust at the pivot point which interferes with the vertical movement of the rod and, if a very heavy buildup forms, could cause an overfiring.

To remedy this problem, W. P. Dawson, Inc. has altered the tube assembly slightly and requested that the old-style tube assemblies be replaced with these units.

Any Duncan kiln with a serial number **prior** to those listed may develop this problem, if the newer tube assembly has not been installed.

DK 716-1	B10519	DK 1020-1	B08263
DK 716-2	B09428	DK 1020-2	B08393
DK 820-1	B10232	DK 1020-3	B10278
DK 820-1C	B10096	DK 1020-4	B11899
DK 820-2	B10302	DK 1029-1	B09105
DK 820-2C	B10165	DK 1029-2	B10421
DK 820-3	B09768	DK 1029-3	B09505
DK 820-4	B09757	DK 1029-4	B09519

Note: Any kiln with a metal claw does not need a new tube assembly.



# CONNECTING WIRES

All connecting wires used in Duncan kilns are tinned-copper and are rated for 600 volts and 200° C. They have silicone rubber insulation which remains flexible even after continual exposure to high temperatures and are covered with a nonfraying fiberglass braid to eliminate the chance that bare wire may become exposed, causing a short circuit.

All terminals are machine-cripped onto the wires, thereby consistently producing electrically secure connections. As a result, individual terminals are not available as replacement parts; finished connecting wires must be purchased.

Slip-on terminals are used only on connections to the switches which, due to their positioning, are likely to touch each other. Therefore, we have taken the added precaution of having them insulated to prevent possible short circuits. The other terminals (ring, spade and hook) fit snugly around well-spaced connection points and, when installed correctly, cannot touch each other.

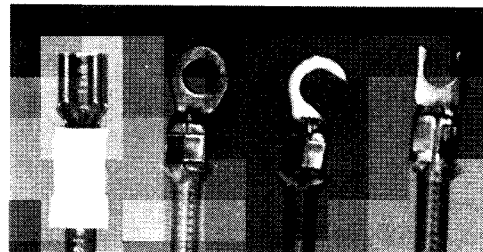

SLIP-ON RING HOOK SPADE

Heat is the greatest enemy of electrical components, so it is important that all connecting wires be checked for deteriorated or burned spots whenever a control panel is removed. Any such wire should be replaced immediately before it causes a problem. As the old saying goes, "An ounce of prevention is worth a pound of cure." Whenever replacing a control panel, press all wires to the front of the panel so they will not come in contact with the heat shield or kiln-sitter tube.

## REPLACING 14" CONNECTING WIRE FOR INTERCONNECT RECEPTACLE

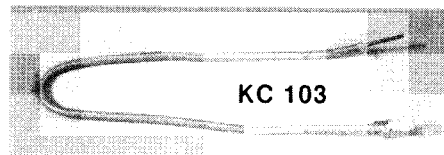

1. *Unplug kiln.*
2. **Remove control panel (see 4.1).**
3. **Remove old wire.**
  - a. Open interconnect receptacle by removing three screws recessed in its top.
  - b. Loosen terminal screw on wire to be replaced.
  - c. Pull wire out through bottom of receptacle.
  - d. Disconnect wire's other end from kiln-sitter switch block.
4. **Install new wire.**
  - a. Connect ring terminal end to kiln-sitter switch block.
  - b. Insert bare end through bottom of interconnect receptacle.
  - c. Using needle-nose pliers, form a hook in bare end.
  - d. Hook bare wire around shaft of terminal screw.
    - 1) Wire should come in contact only with terminal screw to which it is attached.
  - e. Tighten terminal screw firmly.
  - f. Close receptacle and tighten its three screws.

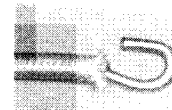

5. Connect wires from elements to switches and reposition control panel on kiln (see 4.2 for detailed instructions).
6. Test kiln with multimeter for electrical soundness (see 2.8 - 2.10).
7. Check kiln-sitter adjustment (see 8.1 - 8.2) before test-firing kiln.

## REPLACING 5'' INTERCONNECT PLUG GROUND WIRE FOR COLLAR

KC 104

1. *Unplug kiln.*
2. **Remove collar control panel** (see 4.1).
3. **Remove old wire.**
  - a. Remove screws that attach interconnect plug to control panel. This frees ring terminal end of ground wire and will partially free interconnect plug for easier removal of ground wire.
  - b. Slip spade terminal end of ground wire off interconnect plug by loosening green hex terminal screw.
4. **Install new wire.**
  - a. Slip spade terminal onto green hex terminal screw.
  - b. Bend terminal slightly, as shown, to ensure snug fit.
  - c. Tighten terminal screw firmly.
5. **Reattach interconnect plug to control panel.**
  - a. Replace screws that hold plug on control panel.
  - b. Place ring terminal on left screw between star washer and hex nut.
  - c. Position spacers between outside of control panel and bottom of plug.
6. **Connect wires from elements to switch and reposition control panel on kiln** (see 4.2 for detailed instructions).
7. **Test kiln with multimeter for electrical soundness** (see 2.8 - 2.10).
8. **Check kiln-sitter adjustment** (see 8.1 - 8.2) before test-firing kiln.

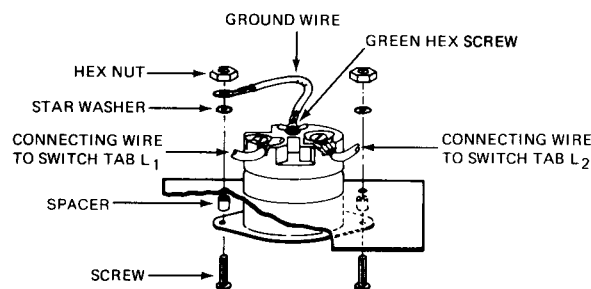

## REPLACING 5'' INTERCONNECT RECEPTACLE GROUND WIRE

KC 113

1. *Unplug kiln.*
2. **Remove control panel** (see 4.1).
3. **Remove old wire.**
  - a. Open interconnect receptacle by removing three screws recessed in its top.
  - b. Loosen green hex terminal screw so wire can be removed.
  - c. Pull wire out through bottom of receptacle.
  - d. Free ring terminal of ground wire.
4. **Install new wire.**
  - a. Reattach ground wire's ring terminal to control panel.
    - 1) Place ring terminal between star washer and hex nut.

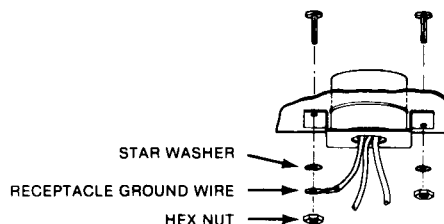

- b. Insert bare end of ground wire through bottom of interconnect receptacle.
  - c. Using needle-nose pliers, form a hook in bare end.
  - d. Hook bare wire around shaft of green hex terminal screw.
    - 1) Wire should come in contact only with terminal screw to which it is attached.
  - e. Tighten terminal screw firmly.
  - f. Close receptacle and tighten its three screws.
5. **Connect wires from elements to switches and reposition control panel on kiln (see 4.2 for detailed instructions).**
  6. **Test kiln with multimeter for electrical soundness (see 2.8 - 2.10).**
  7. **Check kiln-sitter adjustment (see 8.1 - 8.2) before test-firing kiln.**

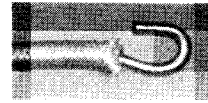

## REPLACING 5' CONNECTING WIRE IN COLLAR (SWITCH TO INTERCONNECT PLUG)

1. **Unplug kiln.**
2. **Remove collar control panel (see 4.1).**
3. **Remove old wire.**
  - a. Remove slip-on terminal from switch tab  $L_1$ .
  - b. Remove screws that attach interconnect plug to control panel. This partially frees interconnect to make removal of wire easier.
  - c. Slip hook terminal off interconnect by loosening terminal screw.
4. **Install new wire.**
  - a. Slip hook terminal end onto terminal screw.
  - b. Bend terminal slightly, as shown, to ensure snug fit.
  - c. Tighten terminal screw firmly.
  - d. Attach slip-on terminal to switch tab  $L_1$ .
5. **Reattach interconnect plug to control panel.**
  - a. Replace screws that hold plug on control panel.
  - b. Place ground wire's ring terminal on left screw between star washer and hex nut.
  - c. Position spacers between outside of control panel and bottom of plug.
6. **Connect wires from elements to switch and reposition control panel on kiln (see 4.2 for detailed instructions).**
7. **Test kiln with multimeter for electrical soundness (see 2.8 - 2.10).**
8. **Check kiln-sitter adjustment (see 8.1 - 8.2) before test-firing kiln.**

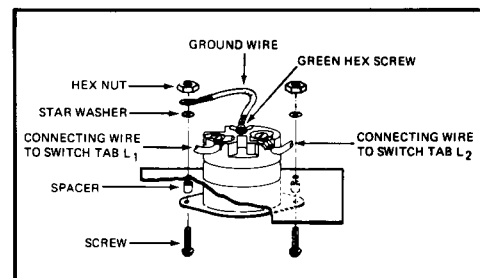
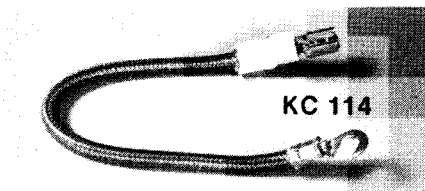

## REPLACING CONNECTING WIRE WITH PILOT LIGHT

1. **Unplug kiln.**
2. **Remove appropriate control panel (see 4.1).**
3. **Remove old wire.**
  - a. Disconnect slip-on terminals from switch tabs P and  $L_2$ .
  - b. Disconnect other end of wire.
    - 1) For switch to kiln-sitter wire:
      - a) Disconnect ring terminal from kiln-sitter switch block.

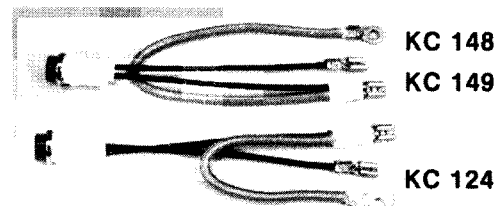

- 2) For switch to interconnect plug wire:
  - a) Remove screws that attach interconnect plug to control panel. This partially frees interconnect to make removal of wire easier.
  - b) Slip hook terminal end of wire off interconnect by loosening terminal screw.
- c. Release pilot light.
  - 1) Depress four small nubs that lock light into control panel.
  - 2) Pull complete unit out through front of control panel.

**4. Install new wire.**

- a. Insert new wire through front of control panel.
- b. Snap pilot light into place.
- c. Slip terminal of separate pilot light wire onto switch tab P and other terminal onto tab L<sub>2</sub>.
- d. Reconnect other end of wire.

- 1) For switch to kiln-sitter wire:
  - a) Connect ring terminal to kiln-sitter's upper right contact.
  - b) Tighten firmly.
- 2) For switch to interconnect plug wire:
  - a) Slip hook terminal onto terminal screw.
  - b) Bend terminal slightly, as shown, to ensure snug fit.
  - c) Tighten terminal screw firmly.
  - d) Reattach interconnect plug to control panel.



- (1) Replace screws that hold plug on control panel.
- (2) Place ring terminal on left screw between star washer and hex nut.
- (3) Position spacers between outside of control panel and bottom of plug.

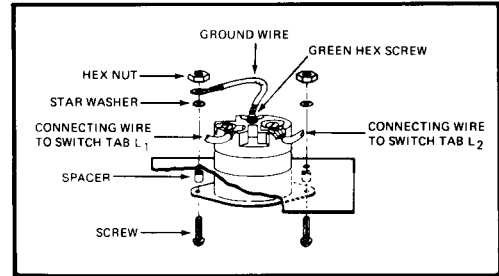

**5. Connect wires from elements to switch and reposition control panel on kiln (see 4.2 for detailed instructions).**

6. Test kiln with multimeter for electrical soundness (see 2.8 - 2.10).
7. Check kiln-sitter adjustment (see 8.1 - 8.2) before test-firing kiln.



**REPLACING CONNECTING WIRE FROM SWITCH TO KILN-SITTER OR ELEMENT**



1. *Unplug kiln.*
2. **Remove control panel (see 4.1).**
3. **For wire that connects switch to kiln-sitter:**
  - a. Remove old wire.
    - 1) Disconnect slip-on terminal from switch tab L<sub>1</sub>.
    - 2) Disconnect ring terminal from kiln-sitter switch block.
  - b. Install new wire.
    - 1) Connect slip-on terminal to switch tab L<sub>1</sub>.
    - 2) Connect ring terminal to kiln-sitter's upper left contact and firmly tighten screw.

**4. For wire that connects switch to element:**

- a. Loosen and remove U-terminal assembly with damaged wire.
- b. Remove hex nut from U-terminal assembly.
  - 1) Replace damaged wire.
  - 2) Loosely replace hex nut.
- c. Replace U-terminal assembly onto element.
  - 1) Slip element ends between terminal clamp and U-terminal so clamp's curved edges form a vise around element.

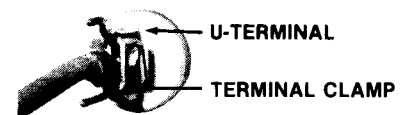

- 2) Since hole in U-terminal is not centered, place widest part toward insulator.
- d. Firmly tighten connection. (The tighter, the better.)
  - 1) Insulator should be snug against heat shield.
  - 2) Element end should be pulled toward you to take up any slack.
- 5. **Connect wires from elements to switch and reposition control panel on kiln (see 4.2 for detailed instructions).**
- 6. **Test kiln with multimeter for electrical soundness (see 2.8 - 2.10).**
- 7. **Check kiln-sitter adjustment (see 8.1 - 8.2) before test-firing kiln.**

# COLLAR AND INTERCONNECT UNIT

Collars are available in different voltages (240 and 208 volts) and in different sizes to fit kilns equipped with an interconnect receptacle to handle the collar (such as the DK 820X and DK 1020). Check the rating plate to be sure that the voltage rating of the collar is the same as the kiln to which it will be added. Also, be sure that the fuse or circuit breaker and the service wiring to the kiln's wall receptacle are adequate for the increased load of the collar. Refer to the chart below for fuse/circuit breaker and wire size. If a customer has installed a collar and trouble develops, be sure the items above are investigated. If in doubt, it is always best to consult an electrician.

**KC 402 on DK 820X (240V)**

or

**KC 412 on DK 820X (208 V)**

1. A 50-amp fuse or circuit breaker
2. #8 copper wire (#6, if circuit exceeds 40 feet)

**KC 404 on DK 1020 (240 V)**

or

**KC 414 on DK 1020 (208 V)**

1. A 60-amp fuse or circuit breaker
2. #6 copper wire (#4, if circuit exceeds 40 feet)

**NOTE: THE SAME WALL RECEPTACLE CAN BE USED FOR A DK 820X OR DK 1020 WITH OR WITHOUT A COLLAR. HOWEVER, THIS DOES NOT MEAN THE WIRING TO THE RECEPTACLE IS ADEQUATE FOR COLLAR ADDITION. HAVE IT CHECKED BY A QUALIFIED ELECTRICIAN.**

Quite often, if a new collar does not operate, the interconnect unit is at fault. Before making this assumption, however, check all the other possible causes (see 2.2).

An interconnect unit consists of a raised female receptacle in the main control panel and a recessed male plug in the collar. If this unit does not fit together properly, the collar may not receive power; therefore, it is very important that a collar control panel be positioned so there is good contact between both parts of the interconnect. To accomplish this, the collar control panel has slotted mounting holes so the panel can move up or down to ensure that the interconnect plug is inserted into the receptacle as far as possible.

Occasionally, a kiln collar will operate fine at the **LOW** and **MED** heat settings, but will stop working at the higher heats. Proper adjustment of the collar control panel, so there is good contact between the interconnect plug and receptacle, will alleviate this problem.

Once you have eliminated all other reasons that could cause the collar not to work and have checked the positioning of the collar control panel, then you can assume that the problem lies with the interconnect unit itself. Check each component for loose or defective parts. On the interconnect plug, just press lightly with your finger on each of the blades. If any can be pushed out of position, the plug is defective. Checking the interconnect receptacle requires more care, because it can be done with the control panel on the kiln and it is therefore possible to overlook unplugging the kiln. First, *unplug kiln*; then insert a screwdriver into the interconnect receptacle's slots and press gently against each of the contact blades to determine if any are loose, requiring the unit to be replaced.

If neither unit appears to be defective, there is no way to check which part is at fault; both may be all right but for some reason are not making contact and the replacement of either part will correct the problem. In such a situation, we would recommend replacing the interconnect plug first, as it is the easier repair procedure; however, by replacing both units you could prevent a second repair job.

**10**

## COLLAR INSTALLATION

1. *Unplug kiln.*
2. **Remove all screws in both bottom hinge plates.**
3. **Remove lid-brace mounting plate from kiln case.**
4. **Remove lid; set it on its edge or upside down to prevent damaging its hardware.**
5. **Remove lid-venting prop.**
6. **Unscrew and remove interconnect receptacle cover, if one is installed on kiln.**
7. **Place collar in position.**
  - a. Loosen mounting screws on collar control panel.
  - b. Slide collar control panel down so that interconnect plug is inserted as far as possible into interconnect receptacle.
  - c. Tap top of collar control panel lightly to ensure good contact.
  - d. Tighten mounting screws firmly.
8. **Test kiln with multimeter for electrical soundness (see 2.8 - 2.10).**

Note: An incorrect meter reading is generally the result of poor contact between the interconnect receptacle and plug.

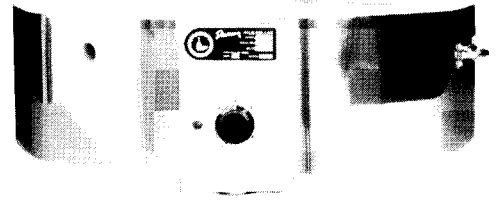

If multimeter is not available, test collar as follows:

- a. Plug in kiln.
  - b. Activate kiln-sitter.
  - c. Turn collar switch to **HI-FIRE**.
    - 1) Elements should glow dull red in a few minutes.
    - 2) If collar will not heat, check for a short or open circuit.
  - d. *Unplug kiln.*
9. **Position lid onto collar.**
    - a. Center handle over control panel.
    - b. Align corners.
  10. **Attach hinge plates to collar.**
    - a. Line up two bottom holes in hinge plate with two top holes in kiln case and replace screws.
    - b. If alignment is difficult, slightly loosen hinge pivot points to allow for variation in height.
    - c. Use center punch, sharp nail or drill to start screw holes in collar case.
    - d. Use new sheet metal screws to attach hinge plates to collar.
  11. **Use old screws to fill holes in kiln case to provide protection from jagged metal.**
  12. **Attach lid-brace mounting plate to collar, using prepunched locator holes.**
  13. **Replace lid-venting prop.**
  14. **Check kiln-sitter adjustment (see 8.1 - 8.2).**
  15. **Test-fire kiln to cone 05, empty except for three evenly spaced shelves with witness cones on each, to:**
    - a. Allow protective oxide coating to form on new elements.
    - b. Check for evenness of firing so adjustment of heat settings can be made, if necessary (see 6.3).

### Special note on 15-amp and 20-amp interconnect units.

All Duncan DK 1020/29 models with A and B prefixed serial numbers (i.e., A03782), excluding the CSA models, have 20-amp interconnect receptacles and plugs. On later models, 15-amp interconnect receptacles and plugs are installed.





The differences between the 15-amp and 20-amp units are the configuration of one of the blades and the absence of a rivet on the base of the 15-amp interconnect receptacle which necessitate a modified receptacle bracket.

A 15-amp interconnect plug can be used to replace a 20-amp plug.

If it is necessary to replace a 20-amp interconnect receptacle and a 20-amp receptacle is not available, a 15-amp unit can be used if both a 15-amp plug and receptacle bracket (KP 224) are installed.

If a collar with a serial number prior to B0270C is installed on a DK 1020 with a 15-amp interconnect receptacle, the units will not fit together. To correct this problem, replace the collar's interconnect plug.

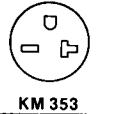
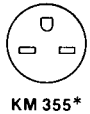
All DK 820X and DK 829 models are equipped with 15-amp interconnect receptacles and plugs.

	EARLY SERIES 20 AMP	CURRENT SERIES 15 AMP
INTERCONNECT PLUG	 KM 354*	 KM 356
INTERCONNECT RECEPTACLE	 KM 353	 KM 355*
INTERCONNECT RECEPTACLE BRACKET	 KP 223	 KP 224

\*THESE UNITS WILL NOT FIT TOGETHER

## INTERCONNECT RECEPTACLE REPLACEMENT

1. *Unplug kiln.*
2. **Remove control panel** (see 4.1).
3. **Remove old interconnect receptacle.**
  - a. Remove screws and nuts that hold receptacle in control panel.
  - b. Pull receptacle free of control panel.
  - c. Open receptacle by removing three screws recessed in its top.
  - d. Loosen terminal screws that hold connecting wires.
  - e. Pull wires out through bottom of unit.
4. **Open new interconnect receptacle.**
  - a. Insert connecting wires through bottom of interconnect receptacle.
  - b. Attach ground wire to green hex terminal screw; other wires can go to either terminal screw.
  - c. Wires should come in contact only with terminal screws to which they are attached.
  - d. Tighten all connections firmly.
5. **Close receptacle.**
  - a. Fit receptacle's blades into proper holes.
  - b. Tighten screws firmly.
6. **Attach interconnect receptacle and bracket to control panel.**
  - a. Position green hex terminal screw toward panel's front.
  - b. Place ring terminal on left screw between star washer and hex nut.
7. **Connect wires from elements to switches and reposition control panel on kiln** (see 4.2 for detailed instructions).
8. **Test kiln with multimeter for electrical soundness** (see 2.8 - 2.10).
9. **Check kiln-sitter adjustment** (see 8.1 - 8.2) before test-firing kiln.

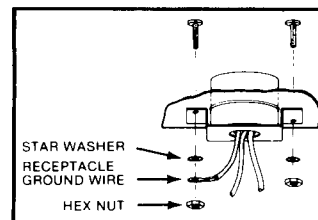
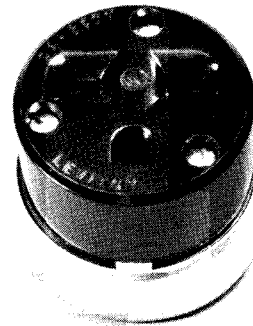

10



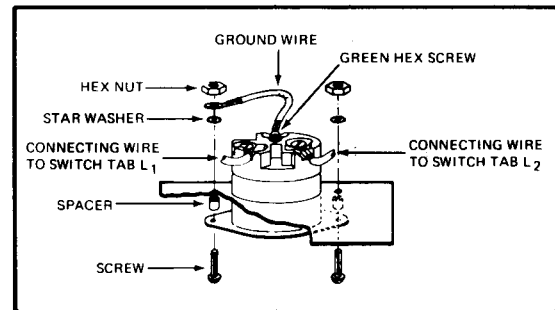
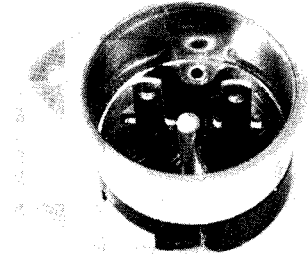

# INTERCONNECT PLUG REPLACEMENT

1. *Unplug kiln.*
2. **Remove control panel (see 4.1).**
3. **Remove old interconnect plug.**
  - a. Remove screws and nuts that attach interconnect plug to control panel.
  - b. Remove slip-on terminal from switch tab  $L_1$ .
  - c. Pull interconnect plug free of control panel.
4. **Remove wires from old plug and install in new one; attach ground wire to green hex terminal screw.**
5. **Position new plug in control panel with green hex terminal screw toward panel's front.**
6. **Attach wire from left terminal screw to switch tab  $L_1$ .**
7. **Attach wire from switch tab  $L_2$  to right terminal screw.**
8. **Install new interconnect plug in control panel.**
  - a. Place ring terminal on left screw between star washer and hex nut.
  - b. Position spacers between outside of control panel and bottom of plug.
9. **Connect wires from elements to switch and reposition control panel on kiln (see 4.2 for detailed instructions).**
10. **Test kiln with multimeter for electrical soundness (see 2.8 - 2.10).**
11. **Check kiln-sitter adjustment (see 8.1 - 8.2) before test-firing kiln.**

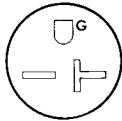

# WALL RECEPTACLES

Wall receptacles for Duncan kilns are available from most local electrical supply houses. The following chart specifies the appropriate models for a number of recognized manufacturers. As a convenience, wall receptacles are available from Duncan, since some distributors have experienced difficulty in obtaining them locally.

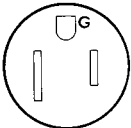
KILN MODEL	RECEPTACLE (2-pole, 3-wire grounding)	
	NEMA Configuration	Appropriate Commercial Models
ES & DK 716	6-20R 	Arrow-Hart 5861, 5851 Bryant 5461, 5484 Eagle 1876 Hubbell 5461, 5451 Leviton 5823, 55823 5821, 55821 Rodale 2500
ES & DK 820	6-30R 	Arrow-Hart 5700 Bryant 9630-FR Eagle 1234 Hubbell 9330 Leviton 5372, 5376 Rodale 694, 693
DK 820X DK 829 ES & DK 1020 ES & DK 1029	6-50R 	Arrow-Hart 5709 Bryant 9650-FR Eagle 1254 Hubbell 9367 Leviton 5374, 5378 Rodale 559, 554

It is recommended that the wall receptacle be located slightly to the right of the kiln and 18 inches (not more than 36 inches) above the floor. To prevent unnecessary strain on the plug blades, install the receptacle with the ground positioned on the top. A kiln will operate properly only if it is plugged into an outlet that has the correct electrical capacity and voltage. Because improper installation can be hazardous, a wall receptacle should be installed by a qualified electrician. If a kiln connected to an incorrectly wired wall receptacle is turned on, all its metal parts could become energized. This means that if someone were to touch it, he could be severely shocked or even electrocuted. Before installing a kiln, it is a good practice to check the wall receptacle with a multimeter to be sure it is wired correctly. This can be accomplished without removing the faceplate. Protect yourself from possible legal action; *never remove a faceplate from a wall receptacle unless you are a qualified electrician!*

## TESTING WALL RECEPTACLE'S WIRING

1. Check fuses or breakers to be sure they are set.
2. Place meter in correct position (check meter's instructions) on nonmetallic surface to ensure most accurate readings.
3. Adjust zero-set screw so needle rests exactly over zero at left side of AC volt scale.
4. Plug black test lead into common jack and red lead into volt (V) jack.
5. Set function switch to AC volt position.
6. Set range switch on AC volts at next range higher than 240 volts (on most meters this would be either 300 or 500).
7. Observe these cautions!
  - a. Touch only insulated handles of test probes.
  - b. Test probes should only come in contact with item being tested. Do not allow them to touch each other or any other metallic surface.
8. Insert a test probe into each of wall receptacle's slotted openings.

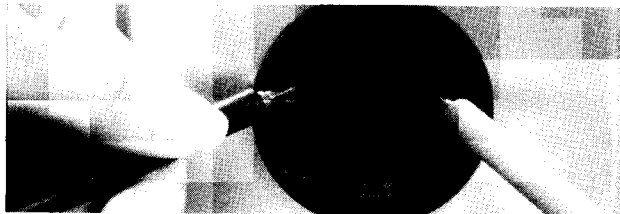

- a. If voltage supply is 240, meter should register between 228 and 252 volts.
  - b. If voltage supply is 208, meter should register between 200 and 218 volts.
  - c. *If meter readings are anything other than the above, do not fire kiln.* The wall receptacle is wired incorrectly and an electrician should be consulted.
9. Place one probe in receptacle's ground opening (round) and the other in a hot opening (slot).

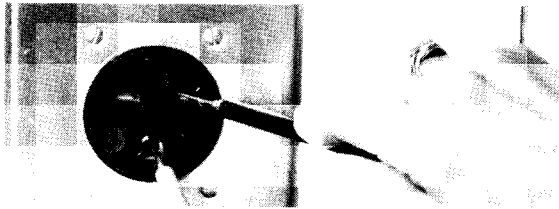

- a. Meter should register between 114 and 126 volts whether supply voltage is 240 or 208; **unless**
  - b. Receptacle is connected to a three-phase delta power supply's "stinger," the hot wire in a three-phase circuit opposite the neutral. In this case, one of the hot to ground measurements will be around 200 volts, instead of 120. This is all right as long as the voltage hot to hot measures between 228 and 252 volts (see **step 8** above).
10. Test between receptacle's other hot opening and ground as in step 9.
  11. Place one probe in wall receptacle's ground opening and the other on receptacle's mounting screw, metal faceplate or cold water pipe.

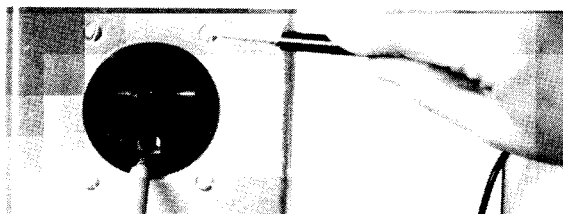

- a. Meter reading should be zero volts (no needle movement).
- b. *If meter reading is anything other than the above, do not plug in kiln.* The wall receptacle is wired incorrectly and an electrician should be consulted.

# CORDS

All cord sets for Duncan kilns come with molded-on plugs and can be used on either 240- or 208-volt models. The cord for each kiln model was chosen to meet both the electrical needs and requirements of that particular model. *Never alter a plug on a kiln cord or use a substitute cord, as such a step will void the warranty.*

Duncan kilns have a three-blade plug and thus a three-wire electrical system: the two hot wires carry current while the third wire is the equipment or life-saving ground which carries no current. This means that a Duncan kiln operates on a full 240-volt (or 208-volt) circuit rather than splitting the voltage into two 120-volt circuits.

*A kiln's cord should never be allowed to touch the kiln case due to the high temperatures the case reaches during firing.* It has been our experience that the height of the receptacle above the floor (see 11.1) and the position of the kiln in relation to the receptacle are the most important factors in preventing this from happening.

*An extension cord should never be used on a kiln.* The use of an extension cord usually means the kiln is positioned quite a distance from the outlet, thereby increasing the chances it may infringe into a work or traffic area. This would create the possibility of someone tripping over it or perhaps jarring the kiln during firing as a result. Extension cords increase the chance of a faulty connection and are not allowed in most electrical codes.

Noncorrosive, nonflammable fiberglass sleeving has been added to the cord's lead wires as secondary insulation in case they should come in contact with the heat shield during firing.

Cord strain relief bushings are used to securely anchor, insulate and protect the cord at its point of entry into the control panel.

## REPLACEMENT

1. *Unplug kiln.*
2. **Remove control panel (see 4.1).**
3. **Disconnect cord's lead wires.**
4. **Release cord and strain relief bushing from control panel.**
  - a. For DK 716 and DK 820, use channel locks or other large pliers.
    - 1) Squeeze the portion of strain relief bushing inside control panel and, with slight rocking motion, press unit out of position. At the same time, with your other hand, pull cord out.
    - 2) Take care not to rotate strain relief bushing from its normal position, as both control panel hole and strain relief bushing have flat sides that should be lined up for easiest removal.
  - b. For DK 1020/29, loosen strain relief bushing's screws, inside control panel, enough to pull cord out of panel.

All replacement cords are tested for electrical correctness before leaving the factory. However, for safety's sake, you may wish to make the following tests before installing a new cord

1. Check terminals on lead wires to be certain they are on firmly.
2. Test cord for electrical correctness.
  - a. Use either an element tester or multimeter for this test. (See 2.6 for instructions on how to set up multimeter.)
  - b. There should be continuity between:
    - 1) Plug's ground blade (round) and green lead wire.
    - 2) One hot blade and white lead wire.
    - 3) The other hot blade and black lead wire.
  - c. There should be no continuity between plug's ground blade (round) and either the white or black lead wires.

**5. Install new cord.**

- a. Bushing should clamp cord about 1/4-inch from end of cord's casing.
- b. For DK 716 and DK 820 cord:
  - 1) Squeeze bushing closed on cord.
  - 2) Squeezing bushing firmly with channel locks or other pliers,
    - a) Rock unit into hole until it snaps in place.
    - b) Bushing's flap should be positioned up or down due to its design and shape of control panel's hole.
- c. For DK 1020/29 cord, tighten bushing screws firmly so cord cannot slip or turn.

BUSHING FLAP

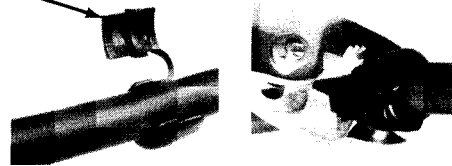

**6. Install fiberglass sleeving on all lead wires of cord.**

**7. Connect cord's lead wires to control panel.**

- a. Connect hot wires (black and white) to lower two contacts on kiln-sitter switch block. It may be necessary to bend neck of DK 1020/29 cord's terminals to ensure a good connection.
- b. Connect ground wire (green) to side of control panel. Its ring terminal should be placed on ground screw between star washer and hex nut.

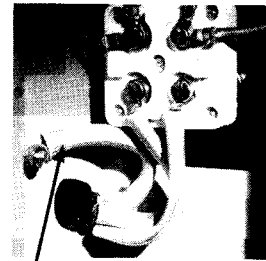

GREEN GROUND WIRE

**8. Connect wires from elements to switch and reposition control panel on kiln (see 4.2 for detailed instructions).**

**9. Test kiln with multimeter for electrical soundness (see 2.8 - 2.10).**

**10. Check kiln-sitter adjustment (see 8.1 - 8.2) before test-firing kiln.**

# BRICK

Insulating bricks are designed specifically for heat retention. They are made from refractory fireclays and kaolins. These clays are mixed with wood fragments and water to form a heavy slip which is dried before firing. When this mixture is fired, the wood burns out, leaving air pockets to form a light, porous brick, with high insulating properties and excellent resistance to heat.

Bricks are graded according to the maximum temperature they can withstand without melting, bloating or deforming. However, the composition of insulating bricks, rated at any particular temperature, will vary depending on the manufacturer. Duncan uses bricks which are conservatively rated at 2300° F. Since elements come in direct contact with the bricks, special care was taken to select a brick with a composition that would not have a detrimental effect on the life of our elements and at the same time would meet all other criteria.

Cracks will form in a kiln's brickwork after firing, particularly in the floor, but are nothing to be concerned about as they serve as expansion joints, opening and closing as the kiln is heated and cooled. Repeated heating and cooling will loosen the bond between the particles so the bricks will gradually lose their strength, eventually crumbling from fatigue. Very few kilns used by ceramics hobbyists will ever reach this point, however.

## WALL BRICK

When used for kiln walls, insulating bricks are not cemented together. The bricks are shaped so that they fit together snugly and are held in position by the kiln case. Replacement bricks are sized and shaped to fit a particular model and are not interchangeable. Each brick has a different end-bevel, depending on whether it is for the seven-, eight- or ten-sided kiln model. Replacements are available for any special brick you need, such as terminal, kiln-sitter, peephole, etc. Grooved brick is, of course, the most common type.

The Duncan brick groove is designed to hold the element firmly in place, eliminating the need for pinning yet ensuring heat radiation into the interior of the kiln and enough room beyond the coil for easy replacement.

Wall brick should only be replaced when it is too chipped to provide insulation or when it can no longer hold the elements in the grooves. Pinning elements into the grooves with Duncan Element Staples (see 7.3) will sometimes enable brick replacement to be postponed until the elements also need replacing.

Generally, it is not advisable to attempt to patch wall brick, as it usually causes more damage than it corrects. It is almost impossible to use a refractory cement to patch the lip of a grooved brick without contaminating an element.

Whenever glaze gets on a brick, it should be dug out with a screwdriver or knife prior to the next firing, otherwise it will remelt and spread, eventually coming into contact with an element, causing it to fail.

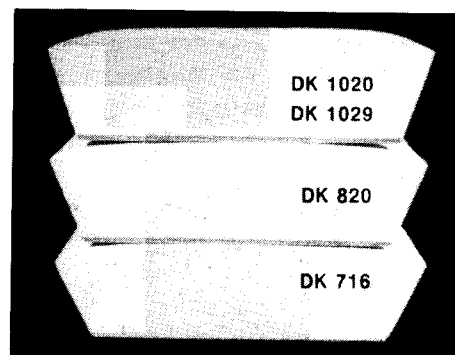

## Wall Brick Replacement

1. Remove lid by removing hinge and lid-brace mounting or chain mounting from kiln case.
2. Free elements from bricks to be replaced.
  - a. Heat elements to soften them.
    - 1) With lid open, turn appropriate switch to **HI-FIRE** until elements glow dull red, then turn kiln off and *unplug it*; or
    - 2) *Unplug kiln* and, with a propane torch, heat the portion of the elements that will be disturbed.
  - b. Use needle-nose pliers to remove elements.
    - 1) Lift **hot** elements up and out of grooves very gently.
    - 2) Pull them sufficiently free of element slots to allow removal of bricks.
3. Loosen case clamps and remove only as many screws (handle, lid-brace mounting, etc.) from kiln case as necessary to free bricks to be removed.
4. Remove all bricks carefully.
5. Insert replacement bricks, plus any others that have been removed, with element groove down.
6. Tighten case clamps, aligning peepholes, kiln-sitter tube hole and holes in base plate with case. If new peephole brick does not line up right, it can be sanded to necessary shape.
7. Replace all parts that were removed.
8. Reheat elements.
  - a. Use a propane torch, or
  - b. Plug in kiln and turn it on.
    - 1) Loose elements must not touch each other.
    - 2) *Unplug kiln* after heating.
9. Use closed needle-nose pliers or table knife to carefully push elements into element slots and down into grooves.
10. If top bricks are uneven, use sanding block to sand surface even with adjoining bricks.
11. Test kiln with multimeter for electrical soundness (see 2.8 - 2.10).
12. Vacuum kiln, removing all dust and brick chips.
13. Check kiln-sitter adjustment (see 8.1 - 8.2) before test-firing kiln.

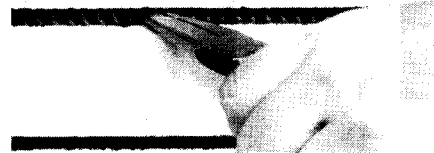
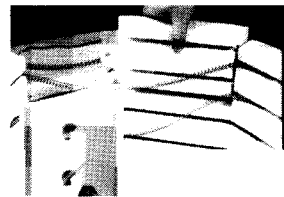
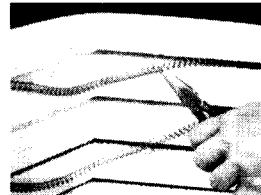
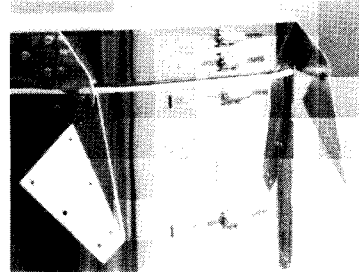

## KILN BOTTOM, DK MODELS

It is recommended that a protective coat of kiln wash be maintained on the brick kiln floor at all times. If glaze drips onto the kiln floor, it should be dug out with a knife or screwdriver prior to the next firing and a fresh coat of kiln wash applied. If this process leaves holes in the floor that might affect the stability of shelves, pack the holes with Duncan Kiln Cement and Sealer or with Duncan Kiln Wash mixed to the consistency of paste; scrape smooth and allow to dry completely before firing.

A kiln bottom should not be replaced strictly for cosmetic reasons. *Fine cracks in the floor do not affect the kiln's firing ability*, they merely serve as expansion joints. An irregular floor is no problem as long as a shelf can be stabilized on it, for ware usually is not placed directly on the kiln floor (see *Owner's Manual*, page 15).

A damaged bottom can normally be replaced easily following Bottom Replacement Method #1. Occasionally, however, a kiln bottom is so badly cracked and crumbled that turning the kiln upside down could cause the floor to fall apart and damage the underside of the lid. When this risk exists, replace the kiln bottom by using Method #2.

## DK Bottom Replacement, Method #1: Kiln Upside Down

1. *Unplug kiln.*
2. Place pad of newspapers on floor to prevent scarring top of lid.
3. Remove cone supports from kiln-sitter tube.
4. Carefully turn kiln upside down, holding lid closed.
5. Mark case and base plate with a crayon or grease pencil, indicating position of base plate.
6. Remove screws that hold base plate in position.
7. Loosen case clamps near bottom of kiln and pry off base plate with screwdriver.
8. Loosen all case clamps and pull out floor.
9. Vacuum top of wall bricks, after floor is removed, to remove any brick dust left on surface.
10. Position new floor, or other side of old floor, on wall brick.
11. Replace base plate, aligning marks and screwholes in case with those in base plate.
12. Install one screw in base plate opposite case clamps.
13. Tighten case clamps, lining up all screwholes, then replace all screws.
14. Turn kiln right side up and place it on stand.
15. Test kiln with multimeter for electrical soundness (see 2.8 - 2.10).
16. Vacuum kiln, removing all brick dust.
17. Check kiln-sitter adjustment (see 8.1 - 8.2) before test-firing kiln.

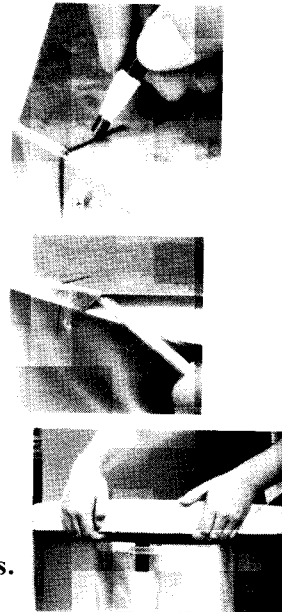

## DK Bottom Replacement, Method #2: Kiln in Upright Position

1. *Unplug kiln.*
2. **If kiln has collar, remove collar and lid.**
  - a. Remove screws on each hinge that connect collar to kiln.
  - b. Lift collar off kiln; set it aside carefully so hinges will not be damaged.
3. **If kiln does not have collar, remove lid.**
  - a. Disassemble hinge pivot points and one arm of lid brace.
  - b. Remove lid; set it on its edge or upside down to prevent damaging its hardware.
4. **Mark case and base plate with a crayon or grease pencil, indicating position of base plate.**
5. **Remove kiln from stand and place on floor.**
6. **Remove screws that hold base plate in position.**
7. **Slightly loosen bottom case clamp only.**
8. **Stand inside kiln and pull up on case handles to free kiln from bottom.**
9. **Walk off kiln bottom and carefully set kiln on floor; kiln will be resting on its case.**
10. **Transfer base plate to new bottom.**
11. **Slide kiln down onto new bottom, aligning marks and screwholes in case with those in base plate.**
12. **Install one screw in base plate opposite case clamps.**
13. **Tighten case clamps, lining up all screwholes, then replace all screws.**
14. **Replace lid (or collar) and place kiln on stand.**

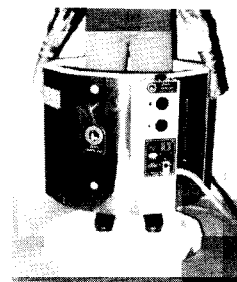



15. Test kiln with multimeter for electrical soundness (see 2.8 - 2.10).
16. Vacuum kiln, removing all brick dust.
17. Check kiln-sitter adjustment (see 8.1 - 8.2) before test-firing kiln.

## KILN LID, DK MODELS

Minor damage to a lid will not affect a kiln's performance. However, if the lid coating is chipped or gouged, leaving a crumbled area, the condition will get worse if the crumbling is not stopped. Simply smooth the area with sandpaper, vacuum up the dust and brush on a thin coat of Duncan Kiln Cement and Sealer. *Never use kiln wash on the underside of the kiln lid.* If lid replacement is necessary it is quite simple to install a new one. Periodically check lid band for tightness. Make necessary adjustments as called for.

### Lid Replacement

1. *Unplug kiln.*
2. **Remove lid-brace mounting plate and handle from old lid.**
3. **Remove all screws from lid hinges.**
4. **Remove old lid and place new lid on kiln.**
5. **Attach old handle to lid.** There are prepunched locator holes in lid band for this.
6. **Position lid so corners are lined up and handle is centered over control panel.**
7. **Attach hinges to lid.**
  - a. Use prepunched locator holes in band for two top holes in each hinge.
  - b. Keep top edge of hinge parallel with band.
  - c. Use center punch or sharp nail to start holes in band for remaining screws.
8. **Attach lid-brace mounting plate to lid, using prepunched locator holes in band as guide.**
9. **Vacuum kiln, removing all brick dust.**



### Hinges

As the kiln heats, both the kiln and its lid expand. Therefore, a Duncan kiln has self-leveling hinges, designed so that the pivot not only rotates but also moves up and down vertically. This allows the lid to float and level itself, keeping undue stress from being placed on the back bricks. Otherwise, at high temperatures, there would be a gap at the kiln's front between the kiln lid and top brick, resulting in heat loss and damage to both the kiln lid and the top bricks where the hinges are attached. If a kiln shows signs of gaping at the front during firing, loosen the hinge pivot slightly.

### Brace

The locking lid brace is both a convenience and a safety feature. However, these units cannot be used interchangeably on all Duncan kilns. Different bends were required to make them fit the different models properly: KE 12 fits the eight-sided models, DK 820, 820X and 829, while KE 19 will fit the DK 716, 1020 and 1029 models.

If the lock on a lid brace does not latch well, it can usually be corrected by bending the locking mechanism with a pair of pliers. Occasionally, stiffness will occur, especially in a new brace. If this happens, take the arm off the kiln and spray silicone lubricant into it. Work the unit back and forth several times to get the area well lubricated and there should be no further problem.

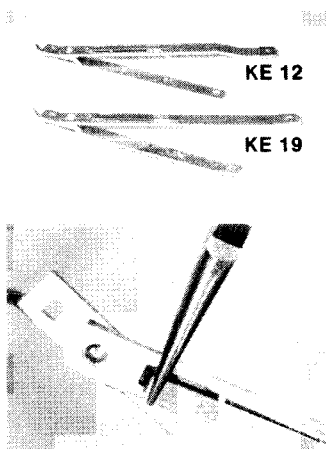

## KILN BOTTOM, ES MODELS

A kiln bottom should not be replaced strictly for cosmetic reasons. *Fine cracks in the floor do not affect the kiln's firing ability*, they merely serve as expansion joints. An irregular floor is no problem as long as a shelf can be stabilized on it, for ware should not be placed directly on the kiln floor (see *Owner's Manual*, page 15).

A damaged bottom can be replaced easily following Bottom Replacement with kiln upside down.

### ES Bottom Replacement, With Kiln Upside Down

1. *Unplug kiln.*
2. Place pad of newspapers on floor to prevent scarring top of lid.
3. Remove cone supports from kiln-sitter tube.
4. Carefully turn kiln upside down, holding lid closed.
5. Mark case and base plate with a crayon or grease pencil, indicating position of base plate.
6. Remove screws that hold base plate in position.
7. Loosen case clamps near bottom of kiln and pry off base plate with screwdriver.
8. Loosen all case clamps and pull out floor.
9. Vacuum top of wall bricks, after floor is removed, to remove any brick dust left on surface.
10. Position new floor, or other side of old floor, on wall brick.
11. Replace base plate, aligning marks and screwholes in case with those in base plate.
12. Install one screw in base plate opposite case clamps.
13. Tighten case clamps, lining up all screwholes, then replace all screws.
14. Turn kiln right side up and place it on stand.
15. Test kiln with multimeter for electrical soundness (see 2.8 - 2.10)
16. Vacuum kiln, removing all brick dust.
17. Check kiln-sitter adjustment (see 8.1 - 8.2) before test-firing kiln.

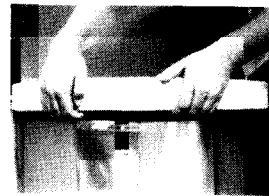
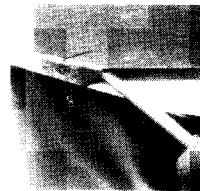

## KILN LID, ES MODELS

### Lid Replacement

1. *Unplug kiln.*
2. Remove chain and handle from old lid.
3. Remove all screws from lid hinges.
4. Remove old lid and place new lid on kiln.
5. Attach old handle to lid. There are prepunched locator holes in lid band for this.
6. Position lid so corners are lined up and handle is centered over control panel.
7. Attach hinges to lid.
  - a. Use prepunched locator holes in band for two top holes in each hinge.
  - b. Keep top edge of hinge parallel with band.
  - c. Use center punch or sharp nail to start holes in band for remaining screws.
8. Attach chain to lid, using screw in threaded hole.
9. Vacuum kiln, removing all brick dust.

# PYROMETER

The pyrometer, with thermocouple, indicates the chamber temperature — it does not control the kiln in any manner. It should not be used in place of pyrometric cones or bars.

The pyrometer is useful for judging the desired temperature and/or "rate of rise." Time, as well as temperature, is needed to properly mature ceramic ware.

The thermocouple is considered the working end of the pyrometer. When the thermocouple is at room temperature, the pointer should rest between the first and the second mark of the °F scale. If it does not, adjust according to the instructions below. You can get the maximum life from your thermocouple if you use it to temperatures below 2200° F or Cone 5. If used above 2100° F (Cone 01/1), insert thermocouple until the reading stabilizes, then remove.

The pyrometer's meter is a sensitive device which should not be dropped, opened or mechanically abused. It should never be connected to any electrical circuit other than the thermocouple lead wires that Duncan has designed for use with this pyrometer. The meter is calibrated for 70° F or room temperature.

The cover of the pyrometer scale is styrene. It may be cleaned with a damp cloth. **Do not** use solvents! The cover may pick up a static electric charge and cause erratic readings. To dispel this charge, breathe on cover as you would to clean your glasses. If the charge persists, wiping the cover with a cloth moistened with a household detergent will usually have a residual antistatic effect.

The accuracy of the pyrometer depends upon the thermocouple in the chamber and the proper loading of the kiln. Use a thermocouple that is in good condition and make sure the load does not shield the thermocouple from heat.

**Note:** The electrical energy which moves the pointer is in the millivolt range — less than 1000 times than that in a common flashlight battery — it will not shock you.

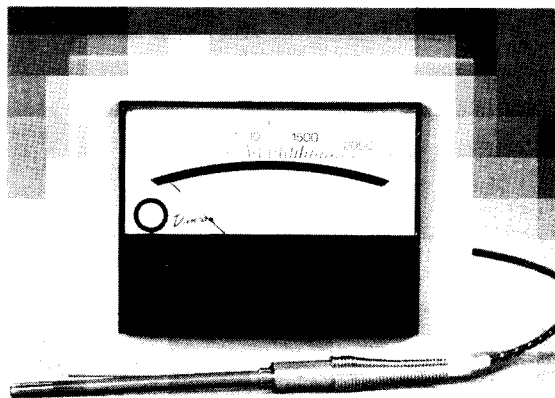

# INSTALLATION

1. Remove the shunt wire from the terminals located on the top of the pyrometer; it is only used during transport to avoid any movement of the meter/pointer.
2. Read the ambient temperature (room temperature) on a thermometer. Turn the "ambient adjust" screw (located at the lower center of the pyrometer case) so that the pointer reads ambient temperature on the pyrometer scale.
3. Attach the thermocouple by fastening the red-coded lead wire under the red terminal and the other lead wire under the yellow terminal. **IMPORTANT:** Check to be sure that the terminals are tightened securely or the possibility of inaccurate temperature readings may result. If you find the meter pointer moves "down" scale rather than "up" scale, just reverse the lead wires connected to the red and yellow terminals and the pointer will move in the opposite direction.
4. Locate prepunched thermocouple guide hole on the side of your Duncan kiln case. Using 3/8" bit, drill a hole through the kiln wall, being sure to center it.
5. Place your pyrometer on the floor or a shelf near the kiln. **NEVER MOUNT IT ON THE KILN.** The distance between the pyrometer location and the thermocouple hole in the kiln case is limited by the length of the lead wire. Do not place your pyrometer where it may be exposed to excessive heat, drafts or dampness. Temperature changes at the pyrometer will affect the reading on the scale.

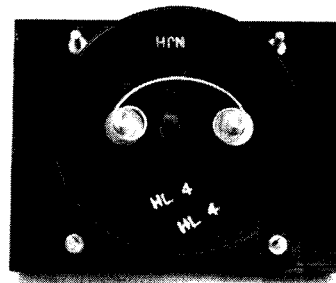

## CAUTIONS

DO NOT INSERT PYROMETER INTO AN OPEN PEEPHOLE, AS LEAD WIRES CAN BE DAMAGED.

DO NOT CONNECT PYROMETER OR THERMOCOUPLE TERMINALS TO ANY MAIN ELECTRICAL SUPPLY.

TO AVOID INACCURATE READINGS, DO NOT SHORTEN OR LENGTHEN YOUR LEAD WIRES OR SUBSTITUTE OTHER THERMOCOUPLES OR LEAD WIRES WITH YOUR DUNCAN UNIT.

DO NOT CONTINUALLY EXPOSE THE THERMOCOUPLE TO TEMPERATURES ABOVE 2100° F OR INTERMITTENT EXPOSURE TO TEMPERATURES ABOVE 2200° F, OR THE INDICATED TEMPERATURES WILL PERMANENTLY REGISTER BELOW THE ACTUAL TEMPERATURES.

# APPENDIX A<sub>1</sub>

## MODEL ES/DK 716 ELECTRICAL SCHEMATIC

All Duncan 240-volt single-phase models can be operated on any two legs of a three-phase circuit.  
The NEMA configuration for 716 models is 6-20R.

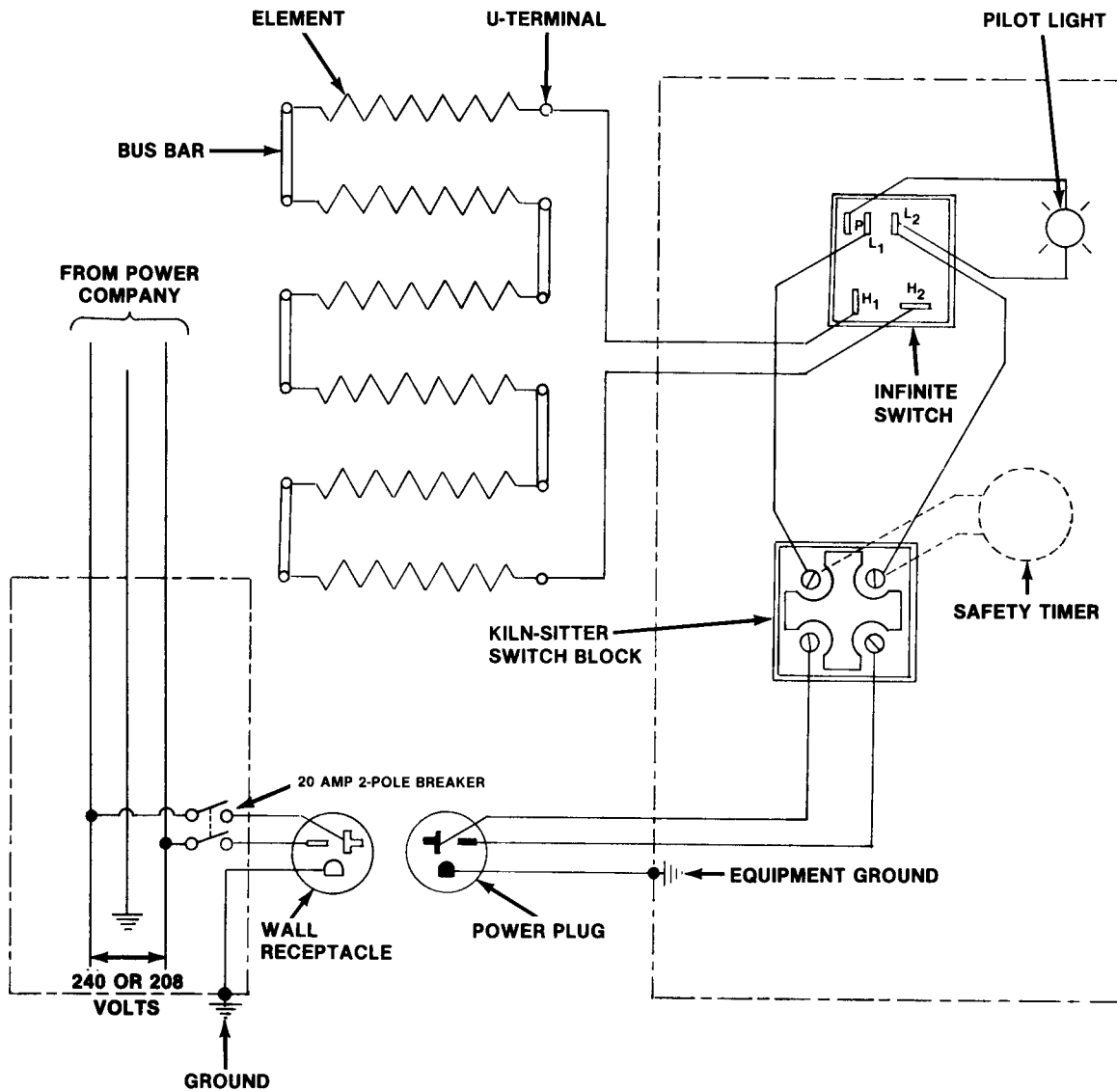

MODEL NO.	VOLTS SINGLE-PHASE	AMPS	WATTS	COPPER WIRE SIZE	FUSE OR CIRCUIT SIZE
ES & DK 716-1	240	15	3600	#12* (#10 if circuit exceeds 40 feet)	20 amps
ES & DK 716-2					
ES & DK 716-3	208	15	3120	#12* (#10 if circuit exceeds 40 feet)	20 amps
ES & DK 716-4					

\*If a larger kiln is planned for the future, install #6 copper wire to avoid the additional expense of rewiring.



# APPENDIX A<sub>2</sub>

## MODEL DK 716 KILN DIAGRAM OF WIRING & IDENTIFICATION OF PARTS

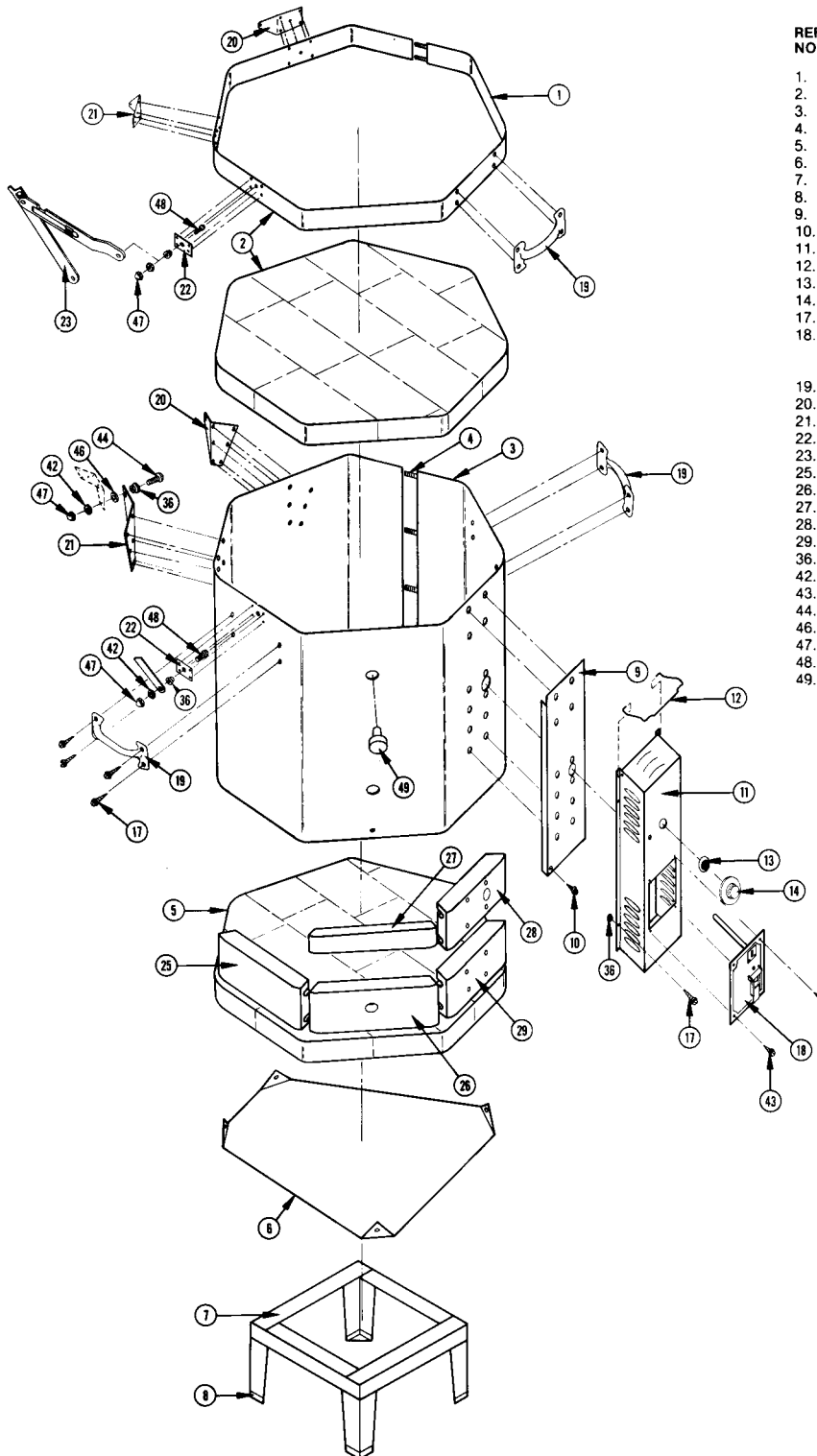

REF. NO.	PART NO.	DESCRIPTION
1.	KC 51	Lid Band w/Clamps
2.	KC 11	Lid (banded and coated)
3.	KC 41	Case w/Clamps
4.	KE 40	Case Clamp
5.	KC 1	Bottom
6.	KP 301	Base Plate
7.	KC 61	Stand w/Feet
8.	KE 30	Stand Feet
9.	KP 21	Heat Shield
10.	KE 302	#8x1" Sheet Metal Screw
11.	KC 21	Control Panel Shell
12.	KE 20	Lid-venting Prop
13.	KM 302	Pal Nut
14.	KM 310	Switch Knob
17.	KE 301	#8x1/2" Sheet Metal Screw
18.	KM 200	Kiln-sitter
		or
	KM 201	Kiln-sitter w/Safety Timer
19.	KE 9	Handle
20.	KC 201	Right Hinge w/Pivot
21.	KC 211	Left Hinge w/Pivot
22.	KC 339	Lid Brace Mounting w/Pivot
23.	KE 18	Locking Lid Brace
25.	KB 1	Grooved Brick
26.	KB 21	Peephole Brick
27.	KB 41	Half Brick
28.	KB 31	Kiln-sitter Brick
29.	KB 11	Terminal Brick
36.	KE 341	1/8" Standoff
42.	KE 332	#10-32 Hex Nut
43.	KE 303	#6x1/2" Sheet Metal Screw
44.	KE 313	#10-32x5/8" Machine Screw
46.	KE 323	#10 Flat Washer
47.	KE 331	#10-32 Acorn Nut
48.	KE 312	#10-32x5/8" Machine Screw
49.	KA 30	Peephole Plug



# APPENDIX A<sub>3</sub>

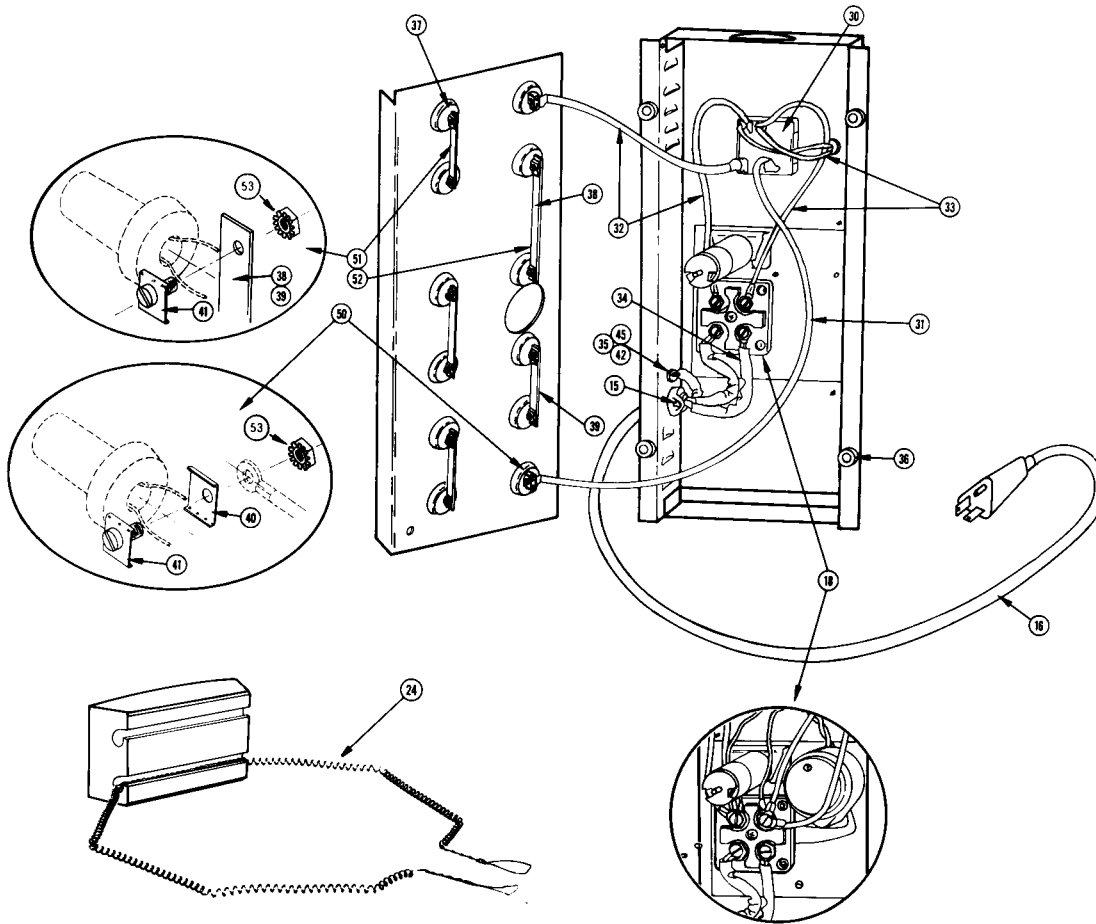

REF. NO.	PART NO.	DESCRIPTION
15.	KM 348	Cord Strain Relief Bushing
16.	KM 321	Cord Set (UL)
	or	
	KM 330	Canadian Cord Set (CSA)
18.	KM 200	Kiln-sitter
	or	
	KM 201	Kiln-sitter w/Safety Timer
24.	KE 201	Element (240 volt)
	or	
	KE 211	Element (208 volt)
30.	KM 300	Infinite Switch w/Pal Nut (240 volt)
	or	
	KM 301	Infinite Switch w/Pal Nut (208 volt)
31.	KC 138	14" Connecting Wire
32.	KC 139	9" Connecting Wire

REF. NO.	PART NO.	DESCRIPTION
33.	KC 149	9" Connecting Wire w/Pilot Light
34.	KM 383	Fiberglass Sleeving
35.	KE 311	#10-32x3/8" Machine Screw
36.	KE 341	1/8" Standoff
37.	KE 60	Insulator
38.	KE 80	Long Bus Bar
39.	KE 70	Standard Bus Bar
40.	KE 90	U-terminal
41.	KE 100	Terminal Clamp
42.	KE 332	#10-32 Hex Nut
45.	KE 321	#10 Star Washer
50.	KC 319	U-terminal Assembly
51.	KC 309	Standard Bus Bar Assembly
52.	KC 301	Long Bus Bar Assembly
53.	KE 334	#10-32 Hex Nut w/Washer

# APPENDIX A<sub>4</sub>

## MODEL ES 716 KILN DIAGRAM OF WIRING & IDENTIFICATION OF PARTS

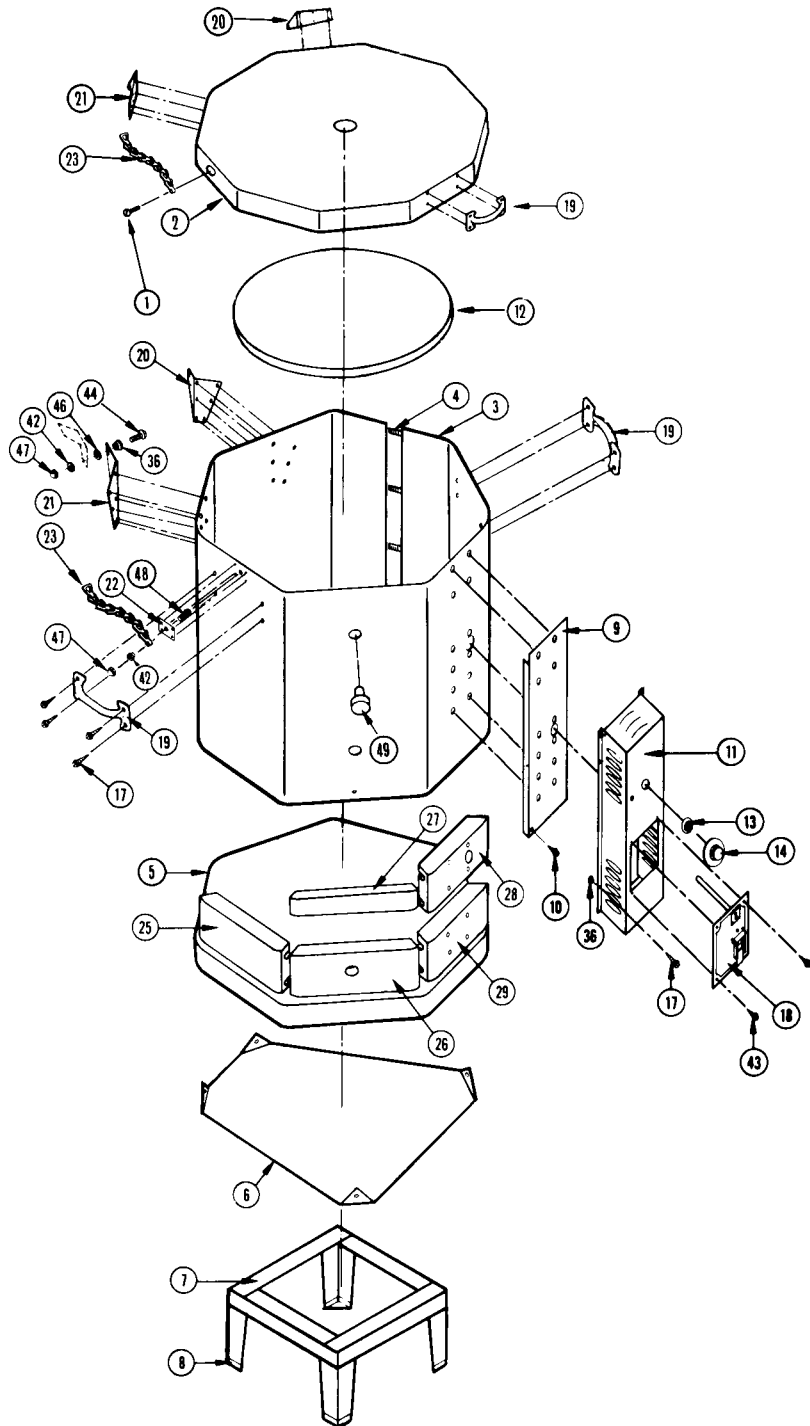

REF. NO.	PART NO.	DESCRIPTION
1.	KE 304	#8-32 x 3/4" Machine Screw
2.	KC 17	Lid w/Band
3.	KC 46	Case w/Clamps
4.	KE 40	Case Clamp
5.	KC 4	Bottom
6.	KP 301	Base Plate
7.	KC 65	Stand w/Feet
8.	KE 30	Stand Feet
9.	KP 21	Heat Shield
10.	KE 302	#8 x 1" Sheet Metal Screw
11.	KC 31	Control Panel Shell
12.	KA 116	716 Hearth Plate
13.	KM 302	Pal Nut
14.	KM 310	Switch Knob
17.	KE 301	#8 x 1/2" Sheet Metal Screw
18.	KM 200	Kiln-sitter
	or	
	KM 201	Kiln-sitter w/Safety Timer
19.	KE 9	Handle
20.	KC 201	Right Hinge w/Pivot
21.	KC 211	Left Hinge w/Pivot
22.	KC 339	Lid Chain Mounting Plate
23.	KE 102	ES 716 Lid Chain
25.	KB 1	Grooved Brick
26.	KB 21	Peephole Brick
27.	KB 41	Half Brick
28.	KB 31	Kiln-sitter Brick
29.	KB 11	Terminal Brick
36.	KE 341	8" Standoff
42.	KE 332	#10-32 Hex Nut
43.	KE 303	#6 x 1/2" Sheet Metal Screw
44.	KE 313	#10-32 x 5/8" Machine Screw
46.	KE 323	#10 Flat Washer
47.	KE 331	#10-32 Acorn Nut
48.	KE 312	#10-32 x 5/8" Machine Screw
49.	KA 30	Peephole Plug





# APPENDIX A<sub>5</sub>

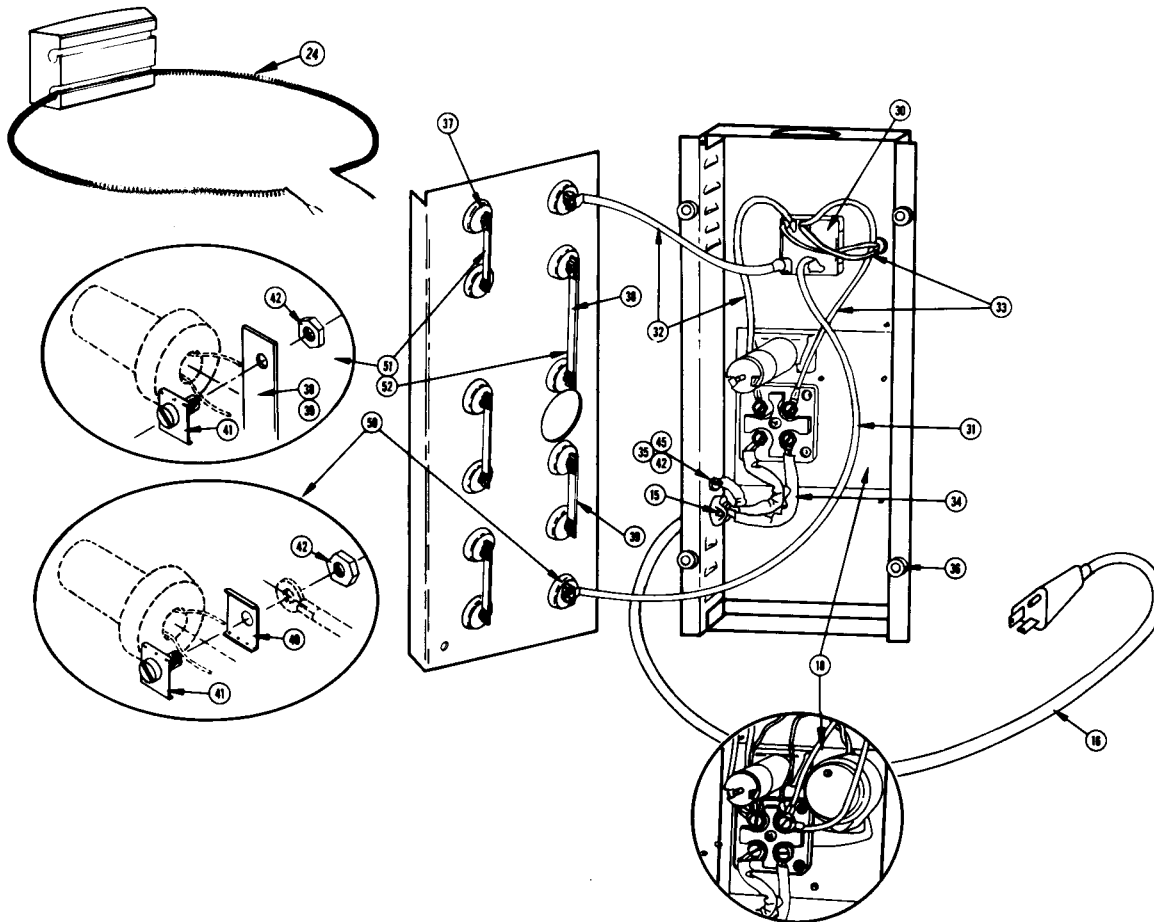

REF. NO.	PART NO.	DESCRIPTION
15.	KM 348	Cord Strain Relief
16.	KM 321	Cord Set
18.	KM 200	Kiln-sitter
	or	
	KM 201	Kiln-sitter w/Safety Timer
24.	KE 201	Element (220/240 volt)
	or	
	KE 211	Element (208 volt)
30.	KM 300	Infinite Switch w/Pal Nut (220/240 volt)
	or	
	KM 301	Infinite Switch w/Pal Nut (208 volt)
31.	KC 138	14" Connecting Wire
32.	KC 139	9" Connecting Wire
33.	KC 149	9" Connecting Wire w/Pilot Light
34.	KM 382	Fiberglass Sleeving
35.	KE 311	#10-32 x 3/8" Machine Screw
36.	KE 341	1/8" Standoff
37.	KE 60	Insulator
38.	KE 80	Long Bus Bar
39.	KE 70	Standard Bus Bar
40.	KE 90	U-terminal
41.	KE 100	Terminal Clamp
42.	KE 332	#10-32 Hex Nut
45.	KE 321	#10 Star Washer
50.	KC 319	U-terminal Assembly
51.	KC 309	Standard Bus Bar Assembly
52.	KC 301	Long Bus Bar Assembly

# APPENDIX B<sub>1</sub>

## MODEL ES/DK 820 ELECTRICAL SCHEMATIC

All Duncan 240-volt single-phase models can be operated on any two legs of a three-phase circuit.  
The NEMA configuration for 820 models is 6-30R.

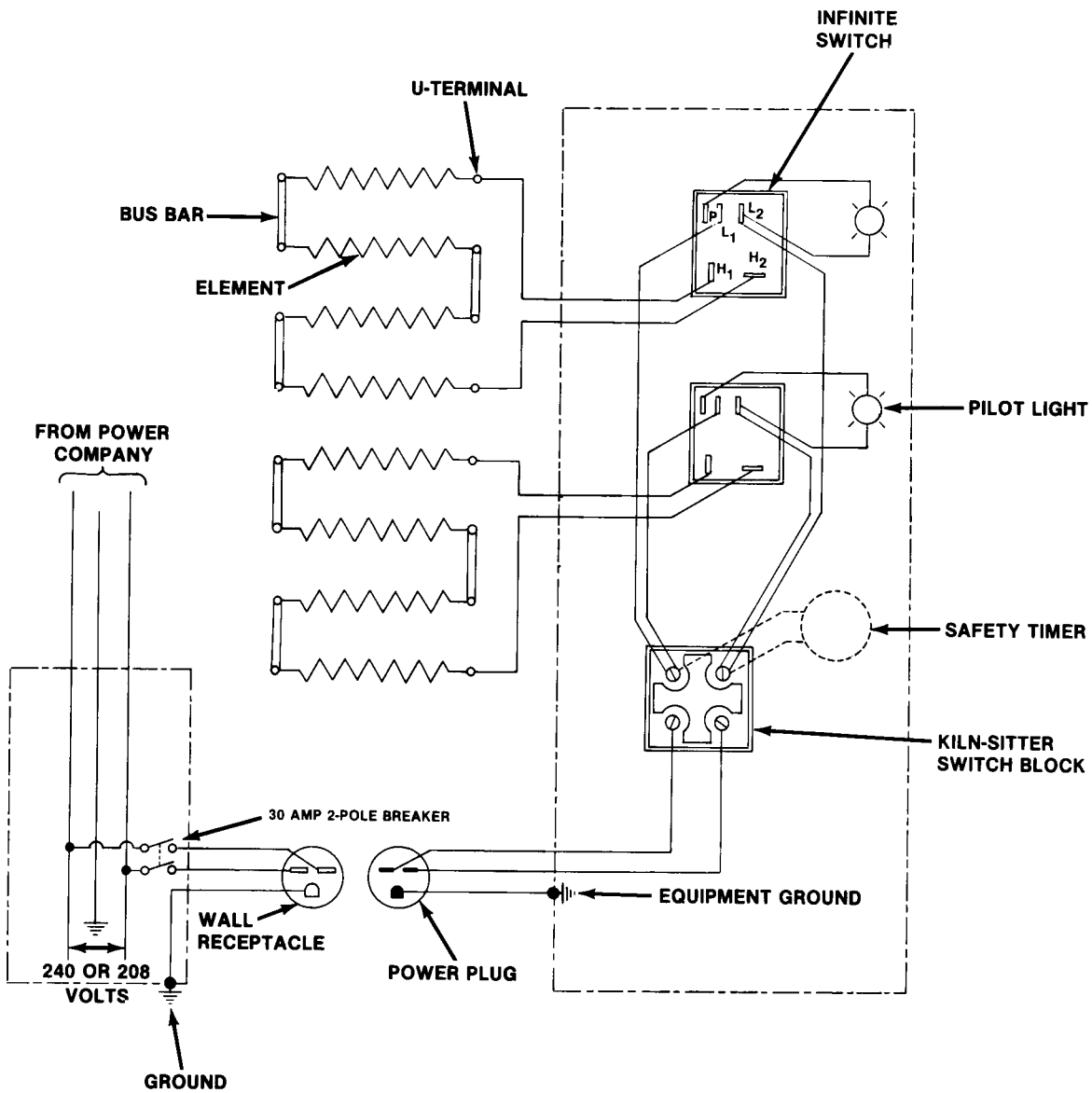

MODEL NO.	VOLTS SINGLE-PHASE	AMPS	WATTS	COPPER WIRE SIZE	FUSE OR CIRCUIT SIZE
ES/DK 820-1 ES/DK 820-2	240	24	5760	#10* (#8 if circuit exceeds 40 feet)	30 amps
ES/DK 820-3 ES/DK 820-4	208		4992		

\*If a larger kiln is planned for the future, install #6 copper wire to avoid the additional expense of rewiring.



# APPENDIX B<sub>2</sub>

## MODEL DK 820 KILN

### DIAGRAM OF WIRING & IDENTIFICATION OF PARTS

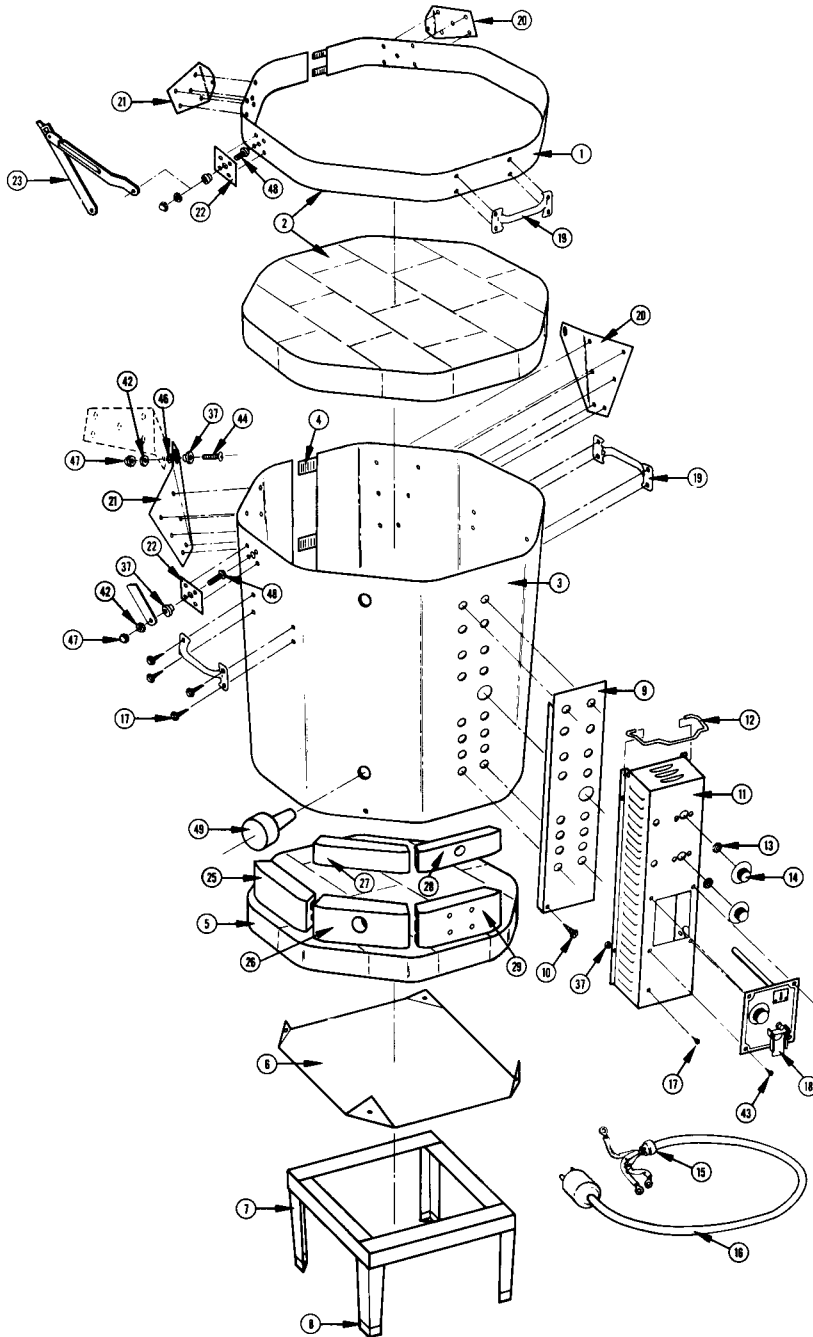

REF. NO.	PART NO.	DESCRIPTION
1.	KC 52	Lid Band w/Clamps
2.	KC 12	Lid (banded and coated)
3.	KC 42	Case w/Clamps
4.	KE 40	Case Clamp
5.	KC 2	Bottom
6.	KP 302	Base Plate
7.	KC 62	Stand w/Feet
8.	KE 30	Stand Feet
9.	KP 28	Heat Shield
10.	KE 302	#8x1" Sheet Metal Screw
11.	KC 22	Control Panel
12.	KE 20	Lid-venting Prop
13.	KM 302	Pal Nut
14.	KM 310	Switch Knob
15.	KM 348	Cord Strain Relief Bushing or Canadian Cord Strain Relief Bushing
16.	KM 322	Cord Set (UL) or Canadian Cord Set (CSA)
17.	KE 301	#8x12" Sheet Metal Screw
18.	KM 200	Kiln-sitter or Kiln-sitter w/Safety Timer
19.	KE 9	Handle
20.	KC 202	Right Hinge w/Pivot
21.	KC 212	Left Hinge w/Pivot
22.	KC 339	Lid-brace Mounting w/Pivot
23.	KE 12	Locking Lid Brace
25.	KB 2	Grooved Brick
26.	KB 22	Peephole Brick
27.	KB 42	Half Brick
28.	KB 52	Kiln-sitter Brick
29.	KB 12	Terminal Brick
37.	KE 341	1/8" Standoff
42.	KE 332	#10-32 Hex Nut
43.	KE 303	#6x12" Sheet Metal Screw
44.	KE 313	#10-32x5/8" Machine Screw
46.	KE 323	#10 Flat Washer
47.	KE 331	#10-32 Acorn Nut
48.	KE 312	#10-32x5/8" Machine Screw
49.	KA 30	Peephole Plug

# APPENDIX B<sub>3</sub>

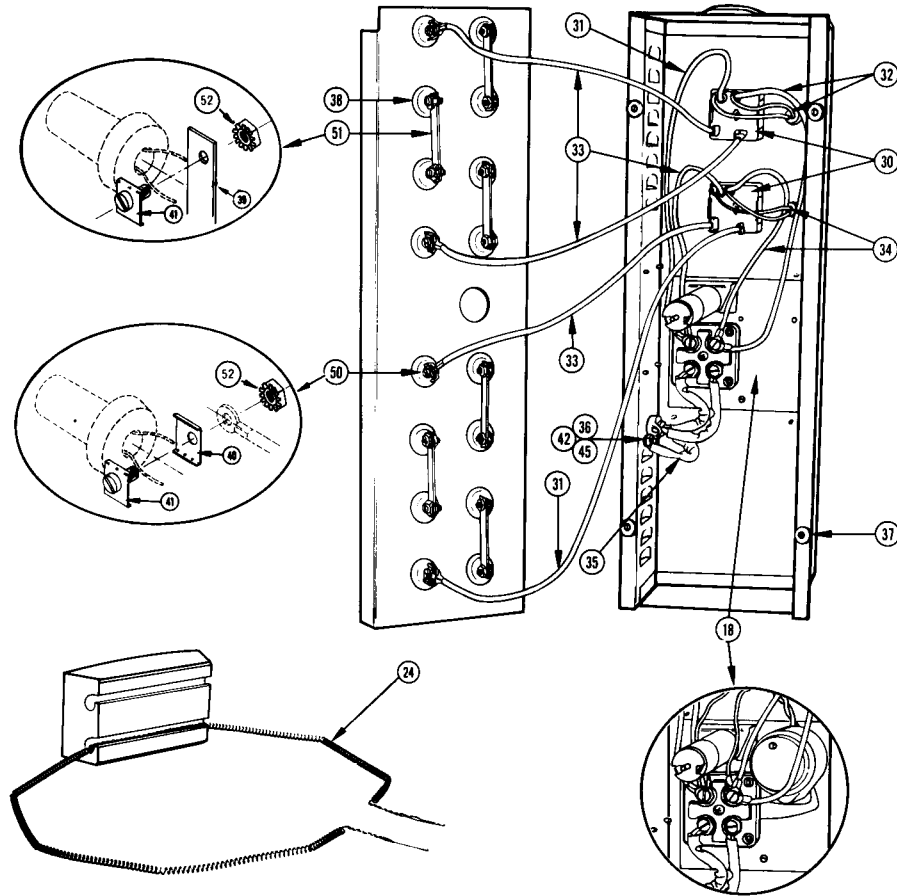

REF. NO.	PART NO.	DESCRIPTION
18.	KM 200	Kiln-sitter
		or
	KM 201	Kiln-sitter w/Safety Timer
24.	KE 202	Element (240 volt)
		or
	KE 212	Element (208 volt)
30.	KM 300	Infinite Switch w/Pal Nut (240 volt)
		or
	KM 301	Infinite Switch w/Pal Nut (208 volt)
31.	KC 138	14" Connecting Wire
32.	KC 148	14" Connecting Wire w/Pilot Light

REF. NO.	PART NO.	DESCRIPTION
33.	KC 139	9" Connecting Wire
34.	KC 149	9" Connecting Wire w/Pilot Light
35.	KM 383	Fiberglass Sleeving
36.	KE 311	#10-32x3/8" Machine Screw
37.	KE 341	1/8" Standoff
38.	KE 60	Insulator
39.	KE 70	Standard Bus Bar
40.	KE 90	U-terminal
41.	KE 100	Terminal Clamp
42.	KE 332	#10-32 Hex Nut
45.	KE 321	#10 Star Washer
50.	KC 319	U-terminal Assembly
51.	KC 309	Standard Bus Bar Assembly
52.	KE 334	#10-32 Hex Nut w/Washer

# APPENDIX B<sub>4</sub>

## MODEL ES 820 KILN DIAGRAM OF WIRING & IDENTIFICATION OF PARTS

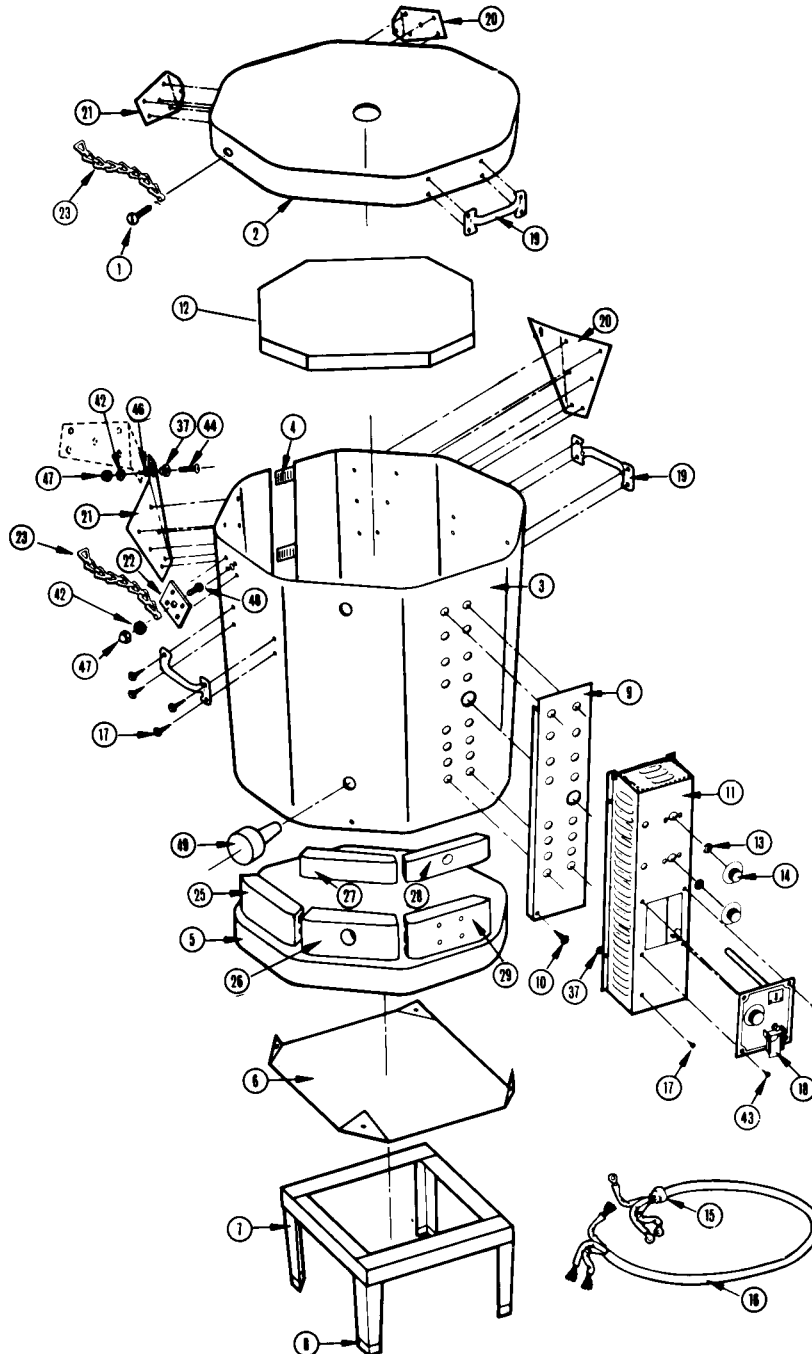

REF. NO.	PART NO.	DESCRIPTION
1.	KE 304	#8-32 x 3/4" Machine Screw
2.	KC 18	Lid w/Band
3.	KC 47	Case w/Clamps
4.	KE 40	Case Clamp
5.	KC 5	Bottom
6.	KP 302	Base Plate
7.	KC 66	Stand w/Feeet
8.	KE 30	Stand Feet
9.	KP 28	Heat Shield
10.	KE 302	#8 x 1" Sheet Metal Screw
11.	KC 32	Control Panel Shell
12.	KA 117	820 Hearth Plate
13.	KM 302	Pal Nut
14.	KM 310	Switch Knob
15.	KM 348	Cord Strain Relief
16.	KM 322	Cord Set
17.	KE 301	#8 x 1/2" Sheet Metal Screw
18.	KM 200	Kiln-sitter
	or	
19.	KM 201	Kiln-sitter w/Safety Timer Handle
20.	KC 202	Right Hinge w/Pivot
21.	KC 212	Left Hinge w/Pivot
22.	KC 339	Lid Chain Mounting Plate
23.	KE 103	ES 820 Lid Chain
25.	KB 2	Grooved Brick
26.	KB 22	Peephole Brick
27.	KB 42	Half Brick
28.	KB 52	Kiln-sitter Brick
29.	KB 12	Terminal Brick
37.	KE 341	8" Standoff
42.	KE 332	#10-32 Hex Nut
43.	KE 303	#6 x 1/2" Sheet Metal Screw
44.	KE 313	#10-32 x 5/8" Machine Screw
46.	KE 323	#10 Flat Washer
47.	KE 331	#10-32 Acorn Nut
48.	KE 312	#10-32 x 5/8" Machine Screw
49.	KA 30	Peephole Plug

# APPENDIX B<sub>5</sub>

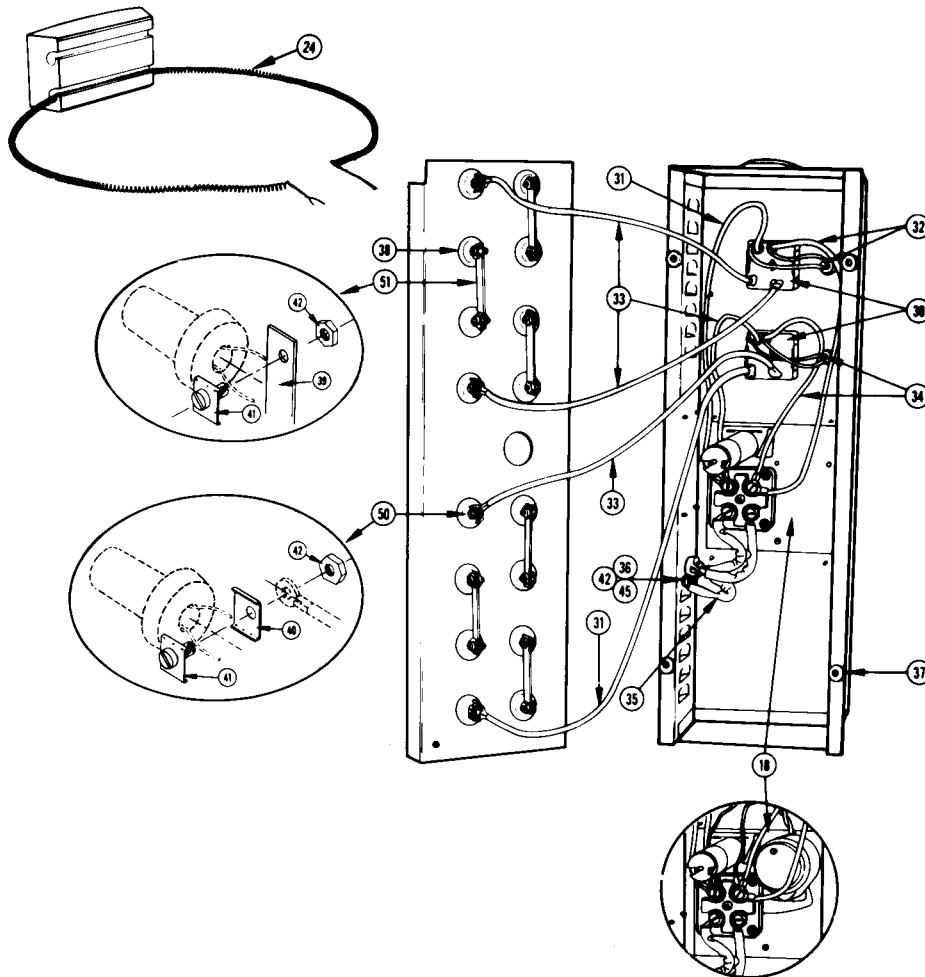

REF. NO.	PART NO.	DESCRIPTION
18.	KM 200 or KM 201	Kiln-sitter
24.	KE 202 or KE 212	Kiln-sitter w/Safety Timer Element (220/240 volt)
30.	KM 300 or KM 301	Infinite Switch w/Pal Nut (220/240 volt)
31.	KC 138	Infinite Switch w/Pal Nut (208 volt)
32.	KC 148	14" Connecting Wire
33.	KC 139	14" Connecting Wire w/Pilot Light
34.	KC 149	9" Connecting Wire
35.	KM 382	9" Connecting Wire w/Pilot Light
36.	KE 311	Fiberglass Sleeving
37.	KE 341	#10-32 x 3/8" Machine Screw
38.	KE 60	8" Standoff
39.	KE 70	Insulator
40.	KE 90	Standard Bus Bar
41.	KE 100	U-terminal
42.	KE 332	Terminal Clamp
45.	KE 321	#10-32 Hex Nut
50.	KC 319	#10 Star Washer
51.	KC 309	U-terminal Assembly
		Standard Bus Bar Assembly



# APPENDIX C<sub>1</sub>

## MODELS DK 820X AND DK 829 ELECTRICAL SCHEMATIC

All Duncan 240-volt single-phase models can be operated on any two legs of a three-phase circuit. The NEMA configuration for DK 820X and 829 models is 6-50R.

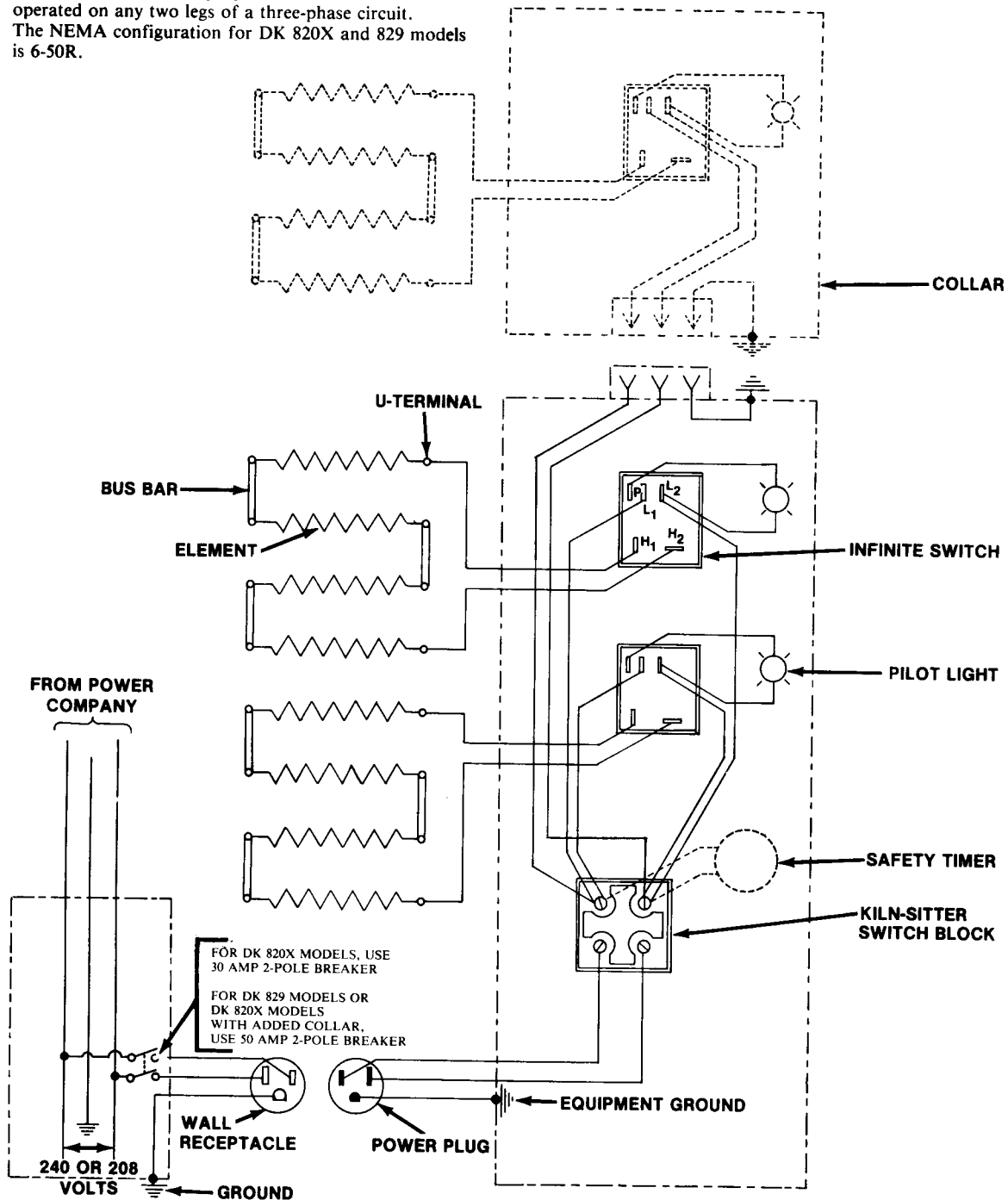

MODEL NO.	VOLTS SINGLE-PHASE	AMPS	WATTS	COPPER WIRE SIZE	FUSE OR CIRCUIT SIZE
DK 820X-1 DK 820X-2	240	24	5760	#10* (#8 if circuit exceeds 40 feet)	30 amps
DK 820X-3 DK 820X-4	208		4992		
DK 829-1 DK 829-2	240	36	8640	#8 (#6 if circuit exceeds 40 feet)	50 amps
DK 829-3 DK 829-4	208		7488		

\*If a collar is to be added in the future, install #8 copper wire.



# APPENDIX C<sub>2</sub>

## MODEL DK 820X AND DK 829 KILNS

### DIAGRAM OF WIRING & IDENTIFICATION OF PARTS

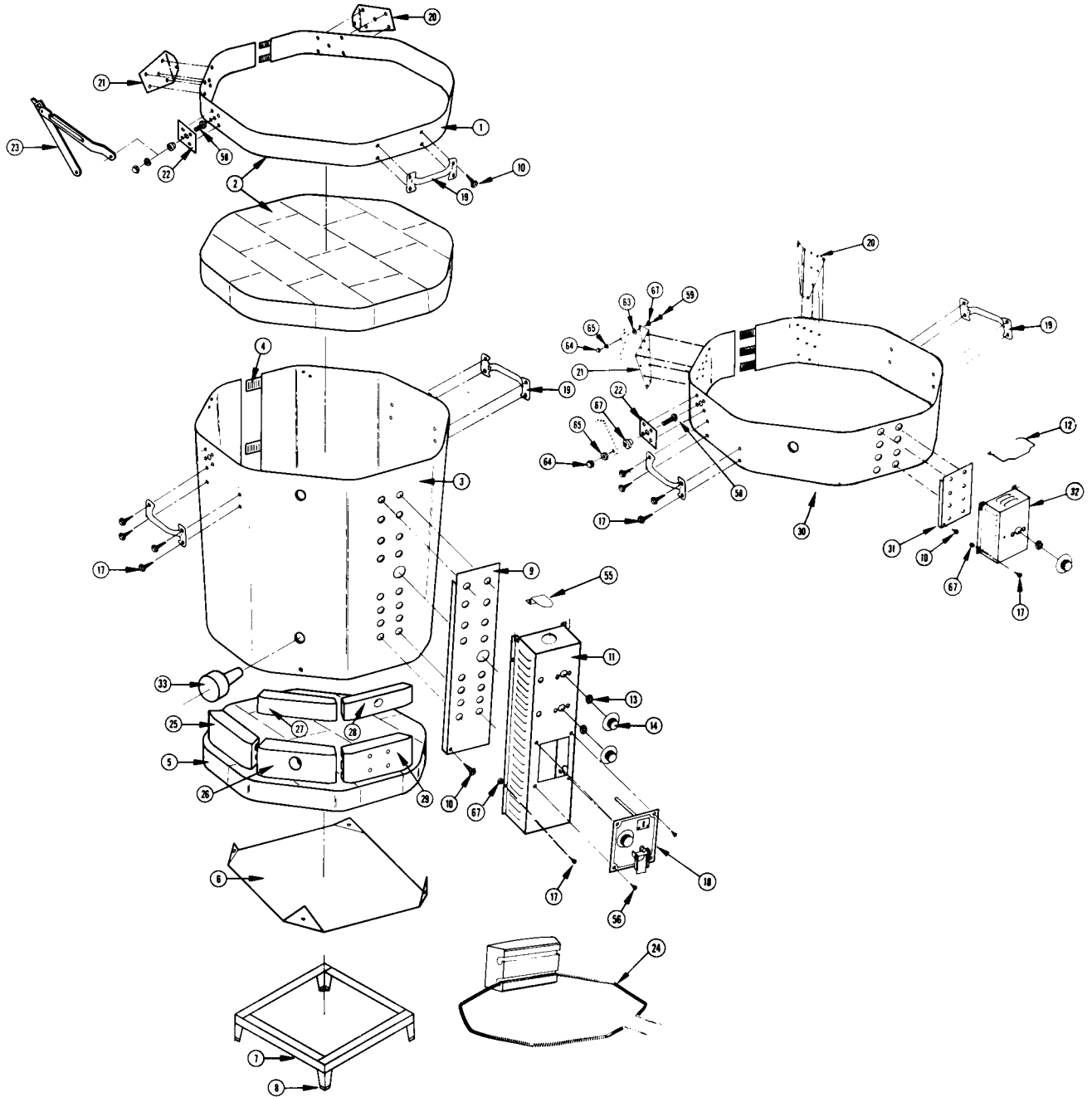

REF. NO.	PART NO.	DESCRIPTION	REF. NO.	PART NO.	DESCRIPTION	REF. NO.	PART NO.	DESCRIPTION
1.	KC 52	Lid Band w/Clamps	19.	KE 9	Handle	58.	KE 303	#6x1/2" Sheet Metal Screw
2.	KC 12	Lid (banded and coated)	20.	KC 204	Right Hinge w/Pivot	58.	KE 312	#10-32x5/8" Machine Screw
3.	KC 42	Case w/Clamps	21.	KC 214	Left Hinge w/Pivot	59.	KE 313	#10-32x5/8" Machine Screw
4.	KE 40	Case Clamp	22.	KC 339	Lid-brace Mounting w/Pivot	63.	KE 323	#10 Flat Washer
5.	KC 2	Bottom	23.	KE 12	Locking Lid Brace	64.	KE 331	#10-32 Acorn Nut
6.	KP 302	Base Plate	24.	KE 202	Element (240 volt)	65.	KE 332	#10-32 Hex Nut
7.	KC 64	Stand w/Feet			or	67.	KE 341	1/8" Standoff
8.	KE 30	Stand Feet		KE 212	Element (208 volt)			
9.	KP 28	Heat Shield	25.	KB 2	Grooved Brick			
10.	KE 302	#8x1" Sheet Metal Screw	26.	KB 22	Peephole Brick			
11.	KC 25	Control Panel	27.	KB 42	Half Brick			
12.	KE 20	Lid-venting Prop	28.	KB 52	Kiln-sitter Brick			
13.	KM 302	Pal Nut	29.	KB 12	Terminal Brick			
14.	KM 310	Switch Knob	30.	KC 45	Collar Case w/Clamps			
17.	KE 301	#8x1/2" Sheet Metal Screw	31.	KP 24	Collar Heat Shield			
18.	KM 200	Kiln-Sitter	32.	KC 24	Collar Control Panel Shell			
		or	33.	KA 30	Peephole Plug			
		KM 201	55.	KM 233	Interconnect Receptacle Cover			





# APPENDIX C<sub>3</sub>

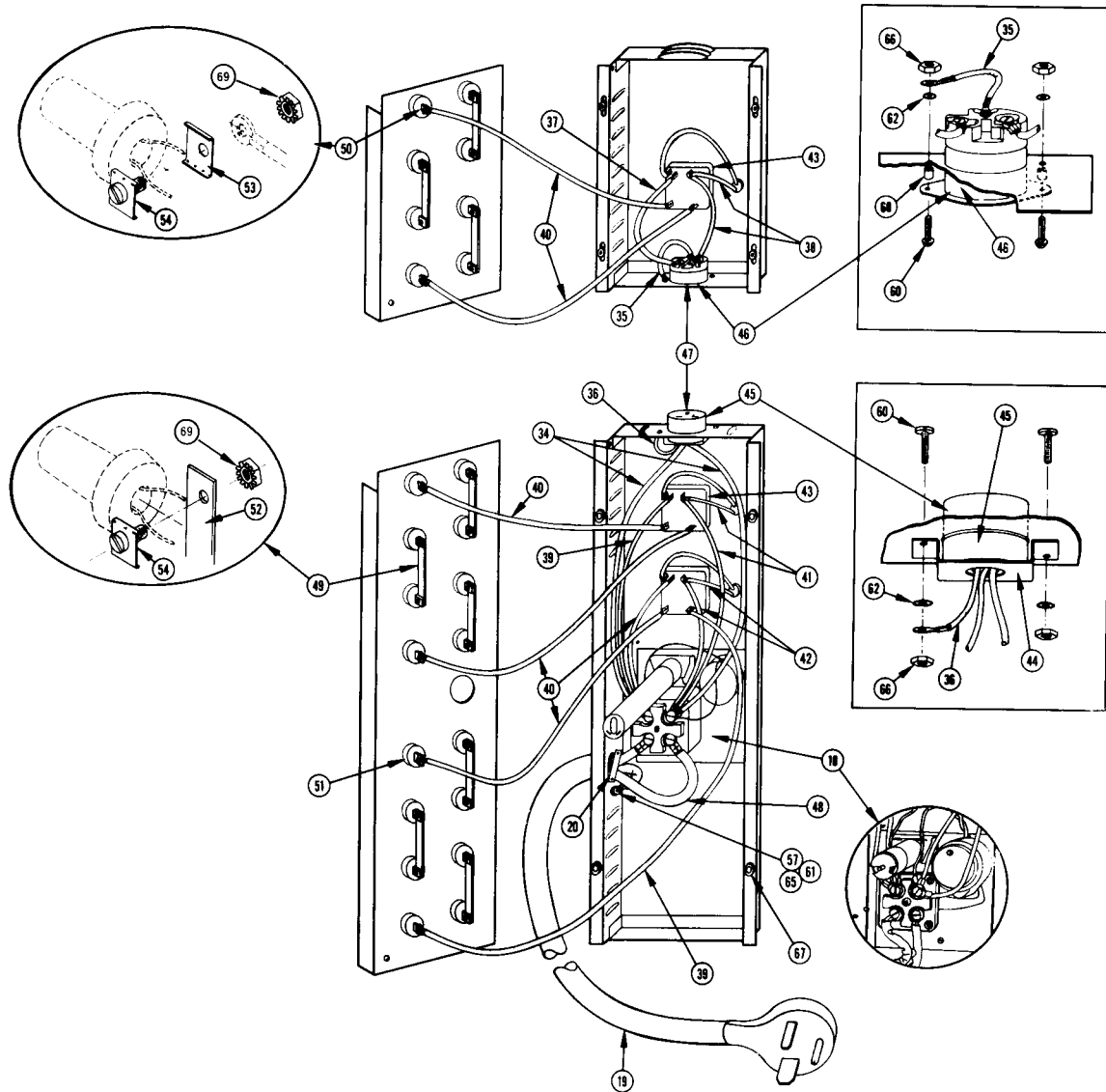

REF. NO.	PART NO.	DESCRIPTION
18.	KM 200	Kiln-sitter
		or
	KM 201	Kiln-sitter w/Safety Timer
19.	KM 333	Cord Set (UL)
20.	KM 343	Cord Strain Relief Bushing
34.	KC 103	14" Connecting Wire for Interconnect Receptacle
35.	KC 104	5" Interconnect Plug Ground Wire
36.	KC 113	5" Interconnect Receptacle Ground Wire
37.	KC 114	5" Connecting Wire
38.	KC 124	5" Connecting Wire w/Pilot Light
39.	KC 139	14" Connecting Wire
40.	KC 139	9" Connecting Wire
41.	KC 148	14" Connecting Wire w/Pilot Light
42.	KC 149	9" Connecting Wire w/Pilot Light
43.	KM 300	Infinite Switch w/Pal Nut (240 volt) or
	KM 301	Infinite Switch w/Pal Nut (208 volt)
44.	KP 223	Interconnect Receptacle Bracket (use w/KM 355)

REF. NO.	PART NO.	DESCRIPTION
45.	KM 355	Interconnect Receptacle (15 amps)
46.	KM 356	Interconnect Plug
47.	KM 359	Interconnect Receptacle and Plug (15 amps)
48.	KM 383	Fiberglass Sleeving
49.	KC 309	Standard Bus Bar Assembly
50.	KC 319	U-terminal Assembly
51.	KE 60	Insulator
52.	KE 70	Standard Bus Bar
53.	KE 90	U-terminal
54.	KE 100	Terminal Clamp
57.	KE 311	#10-32x3/8" Machine Screw
60.	KE 314	#6-32x1/2" Machine Screw
61.	KE 321	#10 Star Washer
62.	KE 322	#6 Star Washer
65.	KE 332	#10-32 Hex Nut
66.	KE 333	#6-32 Hex Nut
67.	KE 341	1/8" Standoff
68.	KE 342	3/16" Spacer
69.	KE 334	#10-32 Hex Nut w/Washer



# APPENDIX D<sub>1</sub>

## MODELS ES/DK 1020 AND ES/DK 1029 ELECTRICAL SCHEMATIC

All Duncan 240-volt single-phase models can be operated on any two legs of a three-phase circuit. The NEMA configuration for DK 1020 and 1029 models is 6-50R.

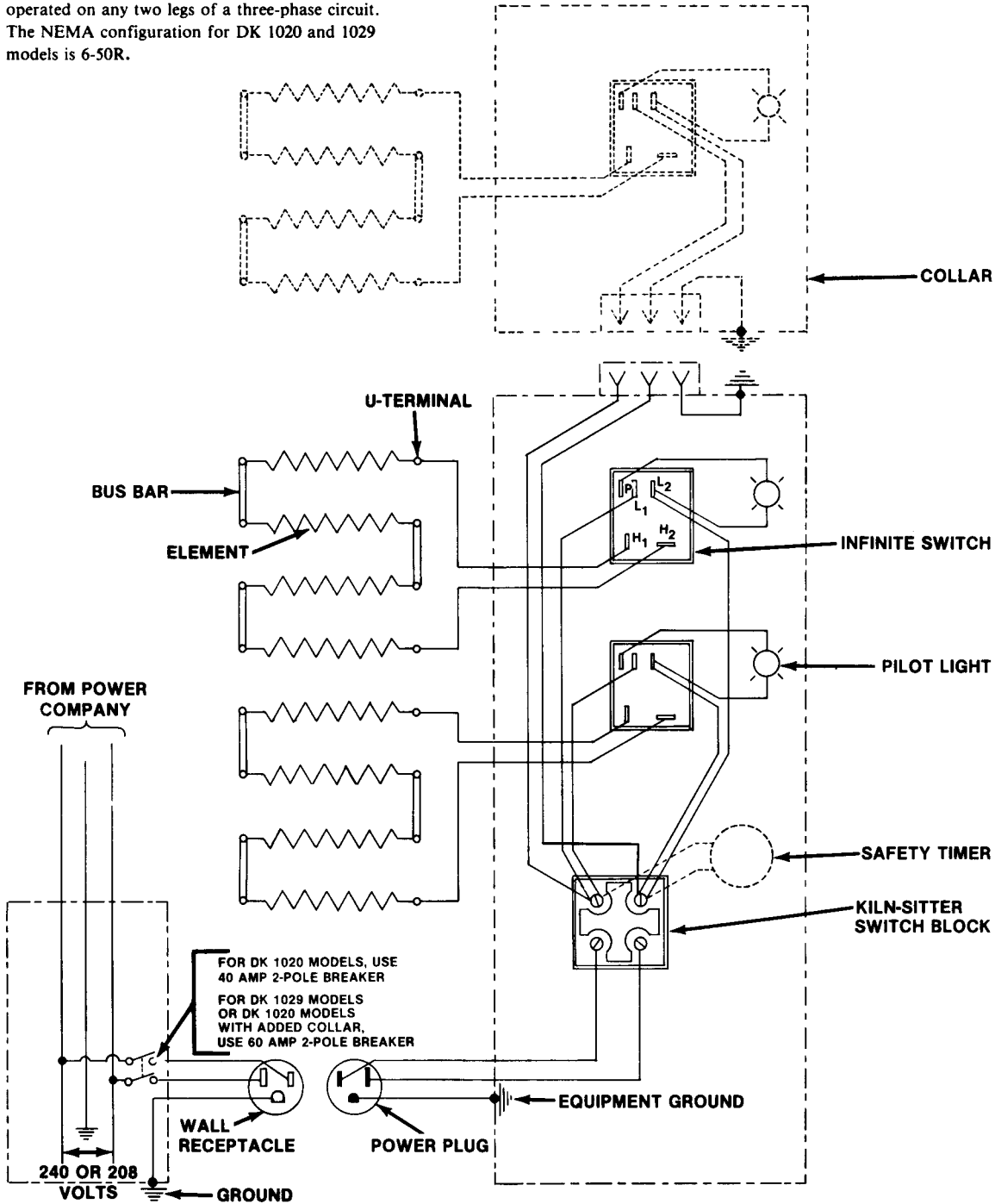

MODEL NO.	VOLTS SINGLE-PHASE	AMPS	WATTS	COPPER WIRE SIZE	FUSE OR CIRCUIT SIZE
ES/DK 1020-1 ES/DK 1020-2	240	30	7200	#8* (#6 if circuit exceeds 40 feet)	40 amps
ES/DK 1020-3 ES/DK 1020-4	208		6240		
ES/DK 1029-1 ES/DK 1029-2	240	45	10800	#6 (#4 if circuit exceeds 40 feet)	60 amps
ES/DK 1029-3 ES/DK 1029-4	208		9360		

\*If a collar is to be added in the future, install #6 copper wire.



# APPENDIX D<sub>2</sub>

## MODEL DK 1020 AND DK 1029 KILNS

### DIAGRAM OF WIRING & IDENTIFICATION OF PARTS

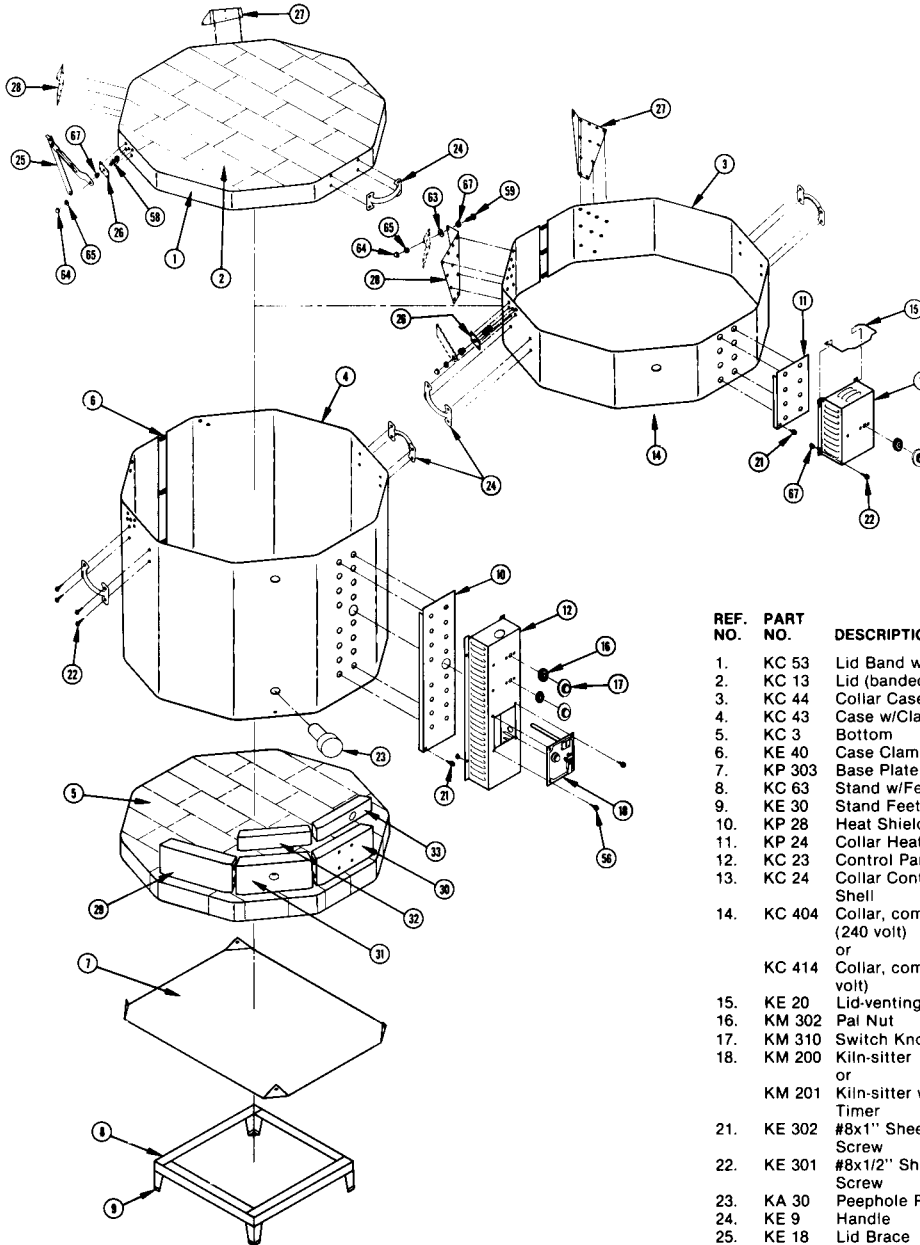

REF. NO.	PART NO.	DESCRIPTION
1.	KC 53	Lid Band w/Clamps
2.	KC 13	Lid (banded and coated)
3.	KC 44	Collar Case w/Clamps
4.	KC 43	Case w/Clamps
5.	KC 3	Bottom
6.	KE 40	Case Clamp
7.	KP 303	Base Plate
8.	KC 63	Stand w/Feet
9.	KE 30	Stand Feet
10.	KP 28	Heat Shield
11.	KP 24	Collar Heat Shield
12.	KC 23	Control Panel Shell
13.	KC 24	Collar Control Panel Shell
14.	KC 404	Collar, complete (240 volt)
		or
	KC 414	Collar, complete (208 volt)
15.	KE 20	Lid-venting Prop
16.	KM 302	Pal Nut
17.	KM 310	Switch Knob
18.	KM 200	Kiln-sitter
		or
	KM 201	Kiln-sitter w/Safety Timer
21.	KE 302	#8x1" Sheet Metal Screw
22.	KE 301	#8x1/2" Sheet Metal Screw
23.	KA 30	Peephole Plug
24.	KE 9	Handle
25.	KE 18	Lid Brace
26.	KC 339	Lid-brace Mounting w/Pivot
27.	KC 203	Right Hinge w/Pivot
28.	KC 213	Left Hinge w/Pivot
29.	KB 3	Grooved Brick
30.	KB 13	Terminal Brick
31.	KB 23	Peephole Brick
32.	KB 43	Half Brick
33.	KB 53	Kiln-sitter Brick
34.	KE 303	#6x1/2" Sheet Metal Screw
35.	KE 312	#10-32x5/8" Machine Screw
36.	KE 313	#10-32x5/8" Machine Screw
37.	KE 323	#10 Flat Washer
38.	KE 331	#10-32 Acorn Nut
39.	KE 332	#10-32 Hex Nut
40.	KE 341	1/8" Standoff



# APPENDIX D<sub>3</sub>

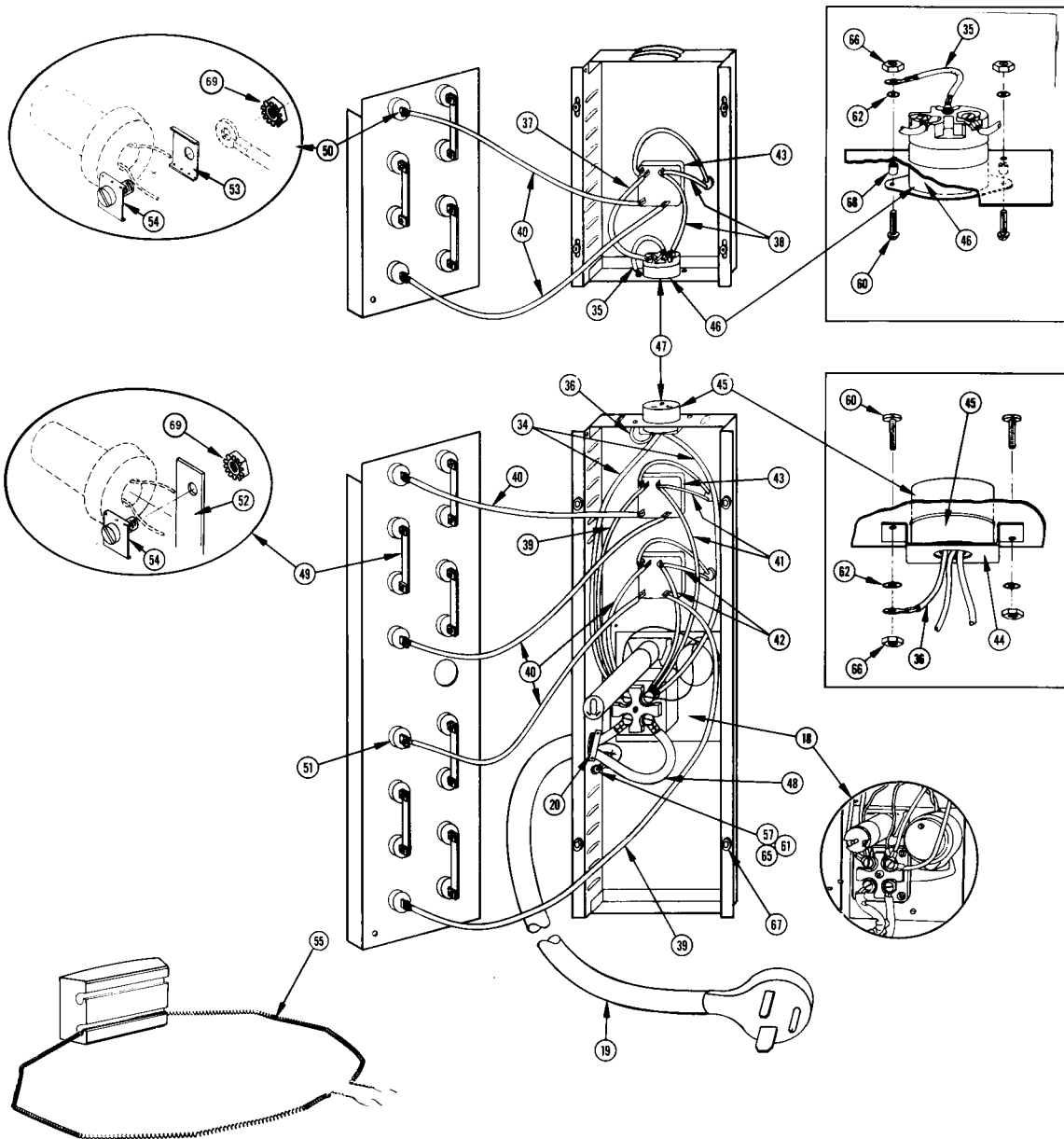

REF. NO.	PART NO.	DESCRIPTION
18.	KM 200	Kiln-sitter
		or
	KM 201	Kiln-sitter w/Safety Timer
19.	KM 333	Cord Set (UL)
		or
	KM 335	Canadian Cord Set (CSA)
20.	KM 343	Cord Strain Relief Bushing
34.	KC 103	14" Connecting Wire for Interconnect Receptacle
35.	KC 104	5" Interconnect Plug Ground Wire
36.	KC 113	5" Interconnect Receptacle Ground Wire
37.	KC 114	5" Connecting Wire
38.	KC 124	5" Connecting Wire w/Pilot Light
39.	KC 139	14" Connecting Wire
40.	KC 139	9" Connecting Wire
41.	KC 148	14" Connecting Wire w/Pilot Light
42.	KC 149	9" Connecting Wire w/Pilot Light
43.	KM 300	Infinite Switch w/Pal Nut (240 volt) or
	KM 301	Infinite Switch w/Pal Nut (208 volt)
44.	KP 224	Interconnect Receptacle Bracket (use w/KM 353) or
	KP 223	Interconnect Receptacle Bracket (use w/KM 355)

REF. NO.	PART NO.	DESCRIPTION
45.	KM 355	Interconnect Receptacle (15 amps) or
	KM 353	Interconnect Receptacle (20 amps)
46.	KM 356	Interconnect Plug
47.	KM 359	Interconnect Receptacle and Plug (15 amps) or
	KM 358	Interconnect Receptacle and Plug (20 amps)
48.	KM 383	Fiberglass Sleeving
49.	KC 309	Standard Bus Bar Assembly
50.	KC 319	U-terminal Assembly
51.	KE 60	Insulator
52.	KE 70	Standard Bus Bar
53.	KE 90	U-terminal
54.	KE 100	Terminal Clamp
55.	KE 223	Element (240 volt) or
	KE 233	Element (208 volt)
57.	KE 311	#10-32x3/8" Machine Screw
60.	KE 314	#6-32x1/2" Machine Screw
61.	KE 321	#10 Star Washer
62.	KE 322	#6 Star Washer
65.	KE 332	#10-32 Hex Nut
66.	KE 333	#6-32 Hex Nut
67.	KE 341	1/8" Standoff
68.	KE 342	3/16" Spacer
69.	KE 334	#10-32 Hex Nut w/Washer



# APPENDIX D<sub>4</sub>

## MODEL ES 1020 AND ES 1029 KILNS

### DIAGRAM OF WIRING & IDENTIFICATION OF PARTS

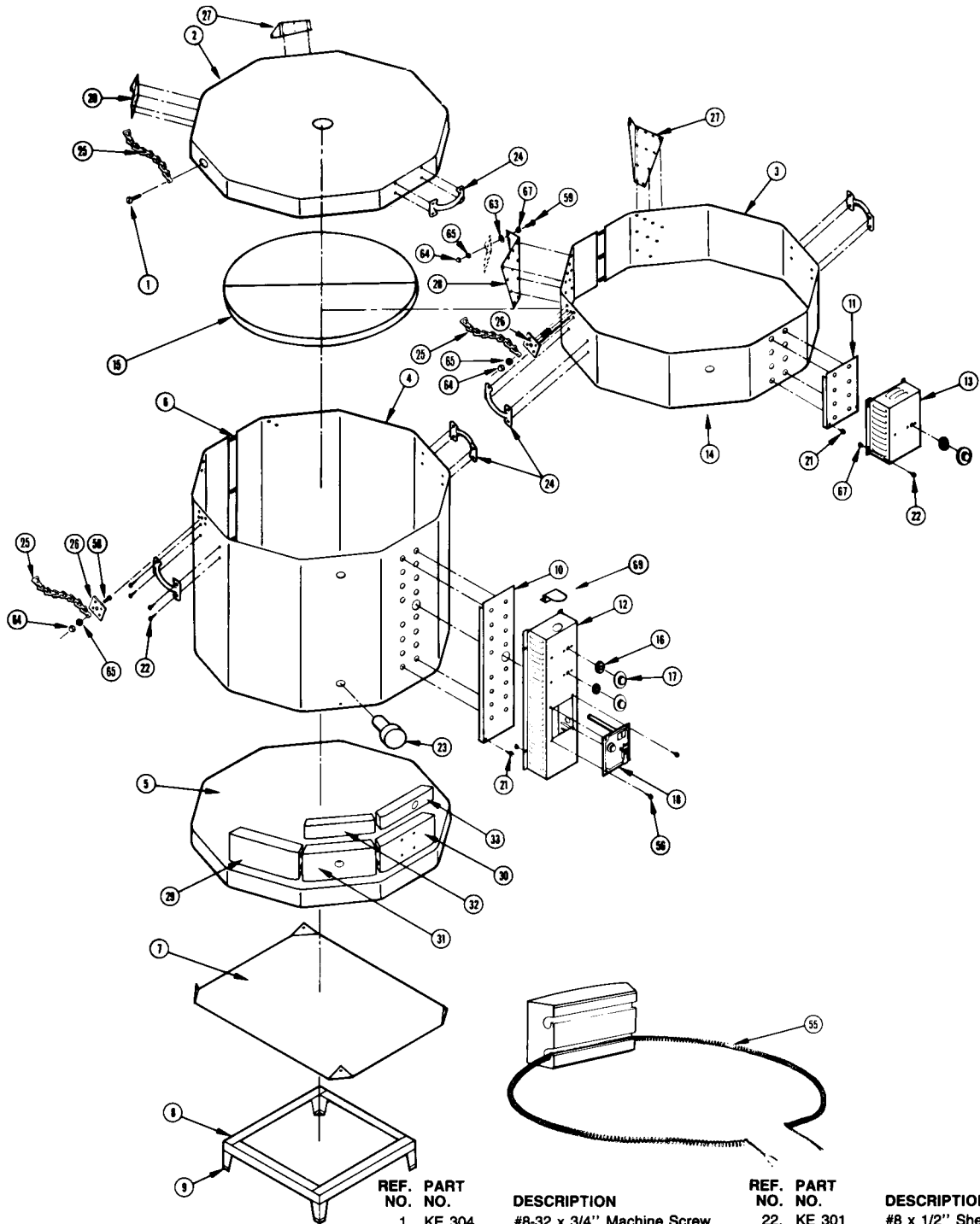

REF. NO.	PART NO.	DESCRIPTION	REF. NO.	PART NO.	DESCRIPTION
1.	KE 304	#8-32 x 3/4" Machine Screw	22.	KE 301	#8 x 1/2" Sheet Metal Screw
2.	KC 19	Lid w/Band	23.	KA 30	Peephole Plug
3.	KC 49	Collar Case w/Clamps	24.	KE 9	Handle
4.	KC 48	Case w/Clamps	25.	KE 104	ES 1020/29 Lid Chain
5.	KC 6	Bottom	26.	KC 339	Lid Chain Mounting Plate
6.	KE 40	Case Clamp	27.	KC 203	Right Hinge w/Pivot
7.	KP 303	Base Plate	28.	KC 213	Left Hinge w/Pivot
8.	KC 67	Stand w/Feet	29.	KB 3	Grooved Brick
9.	KE 30	Stand Feet	30.	KB 13	Terminal Brick
10.	KP 28	Heat Shield	31.	KB 23	Peephole Brick
11.	KP 24	Collar Heat Shield	32.	KB 43	Half Brick
12.	KC 33	Control Panel Shell	33.	KB 53	Kiln-sitter Brick
13.	KC 34	Collar Control Panel Shell	55.	KE 223	Element (220/240 volt)
14.	KC 405	Collar, complete (220/240 volt)		or	
	or		56.	KE 233	Element (208 volt)
	KC 406	Collar, complete (208 volt)	57.	KE 303	#6 x 1/2" Sheet Metal Screw
15.	KA 118	1020/29 Hearth Plate	58.	KE 312	#10-32 x 5/8" Machine Screw
16.	KM 302	Pal Nut	59.	KE 313	#10-32 x 5/8" Machine Screw
17.	KM 310	Switch Knob	63.	KE 323	#10 Flat Washer
18.	KM 200	Kiln-sitter	64.	KE 331	#10-32 Acorn Nut
	or		65.	KE 332	#10-32 Hex Nut
	KM 201	Kiln-sitter w/Safety Timer	67.	KE 341	1/8" Standoff
21.	KE 302	#8 x 1" Sheet Metal Screw	69.	KM 2	Interconnect Receptacle Cover



# APPENDIX D<sub>5</sub>

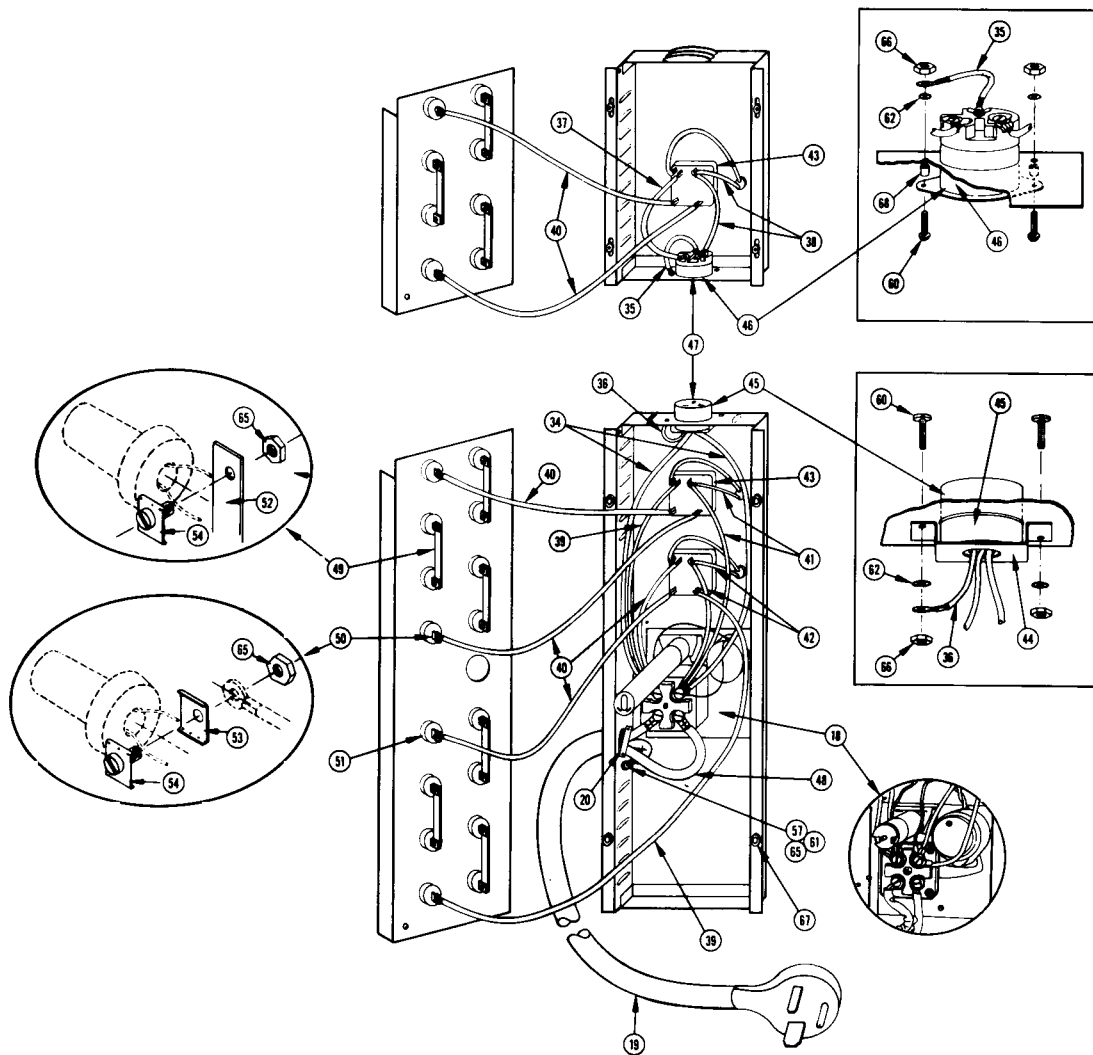

**REF. PART  
NO. NO.**

**DESCRIPTION**

18.	KM 200 or KM 201	Kiln-sitter Kiln-sitter w/Safety Timer
19.	KM 333	Cord Set
20.	KM 343	Cord Strain Relief
34.	KC 103	14" Connecting Wire for Interconnect Receptacle
35.	KC 104	5" Interconnect Plug Ground Wire
36.	KC 113	5" Interconnect Receptacle Ground Wire
37.	KC 114	5" Connecting Wire
38.	KC 124	5" Connecting Wire w/Pilot Light
39.	KC 138	14" Connecting Wire
40.	KC 139	9" Connecting Wire
41.	KC 148	14" Connecting Wire w/Pilot Light
42.	KC 149	9" Connecting Wire w/Pilot Light
43.	KM 300 or KM 301	Infinite Switch w/Pal Nut (220/240 volt) Infinite Switch w/Pal Nut (208 volt)

44.	KP 223	Interconnect Receptacle Bracket
45.	KM 353	Interconnect Receptacle
46.	KM 354	Interconnect Plug
47.	KM 359	Interconnect Receptacle and Plug
48.	KM 383	Fiberglass Sleeving
49.	KC 309	Standard Bus Bar Assembly
50.	KC 319	U-terminal Assembly
51.	KE 60	Insulator
52.	KE 70	Standard Bus Bar
53.	KE 90	U-terminal
54.	KE 100	Terminal Clamp
57.	KE 311	#10-32 x 3/8" Machine Screw
60.	KE 314	#6-32 x 1/2" Machine Screw
61.	KE 321	#10 Star Washer
62.	KE 322	#6 Star Washer
65.	KE 332	#10-32 Hex Nut
66.	KE 333	#6-32 Hex Nut
67.	KE 341	1/8" Standoff
68.	KE 342	3/16" Spacer



# APPENDIX E<sub>1</sub>

## DAWSON KILN-SITTER: CURRENT SERIES MODELS K-10 AND LT-4K

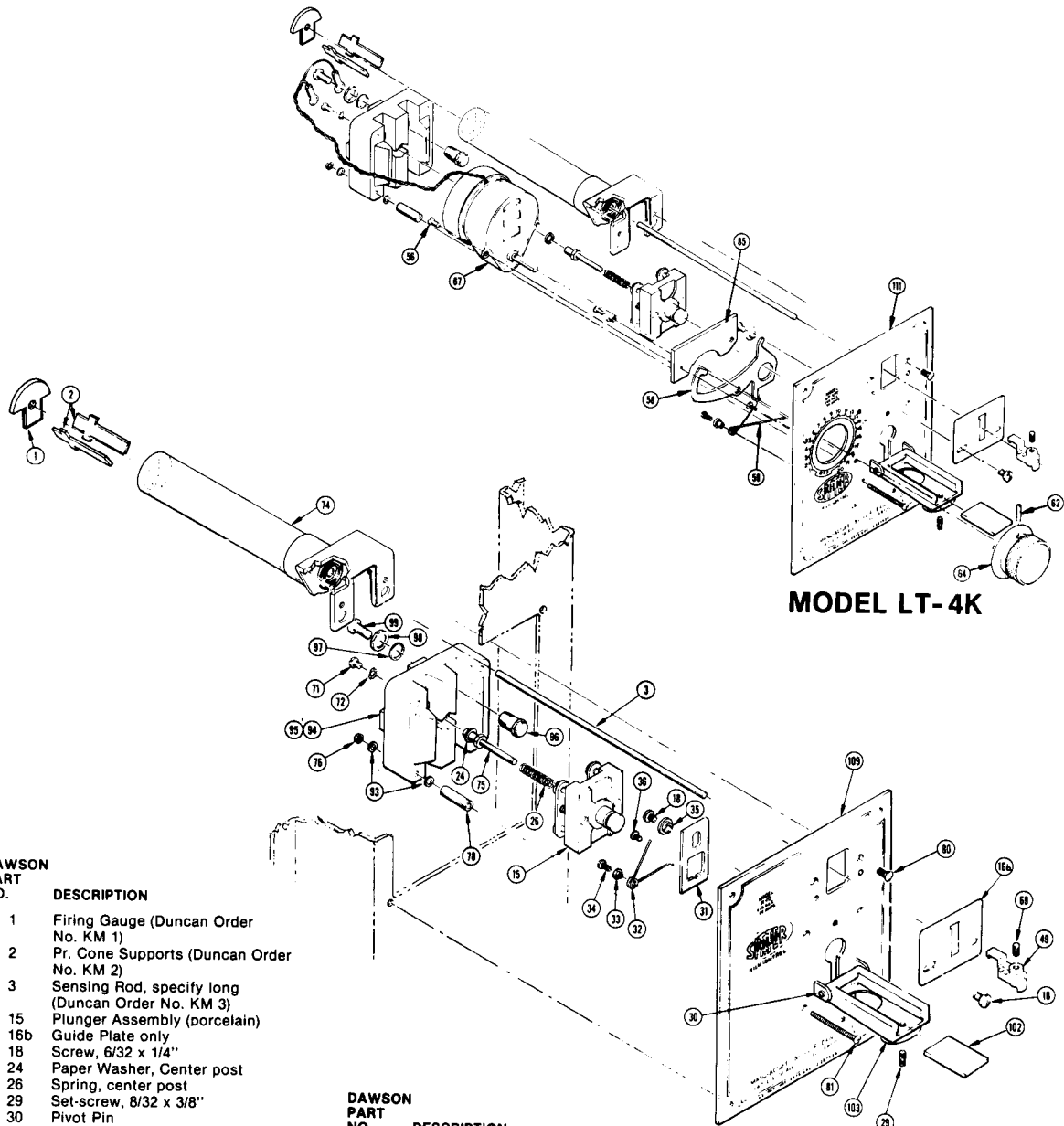

**MODEL LT-4K**

**MODEL K-10**

**DAWSON  
PART  
NO.**

**DESCRIPTION**

- 1 Firing Gauge (Duncan Order No. KM 1)
- 2 Pr. Cone Supports (Duncan Order No. KM 2)
- 3 Sensing Rod, specify long (Duncan Order No. KM 3)
- 15 Plunger Assembly (porcelain)
- 16b Guide Plate only
- 18 Screw, 6/32 x 1/4"
- 24 Paper Washer, Center post
- 26 Spring, center post
- 29 Set-screw, 8/32 x 3/8"
- 30 Pivot Pin
- 31\* Lock
- 32\* Spring, lock
- 33 Retainer, lock spring
- 34 Screw, 4/40 x 1/4"
- 35 Retainer, locking cam or lock
- 36 Screw, lock spring 4/40 x 1/8"
- 49 Claw with set-screw, nylon
- 56\* Screw, motor mounting 6/32 x 1/4"
- 58\* Locking Cam
- 59\* Spring, locking cam
- 62\* Set-screw, knob, 10/32 x 1/2"
- 64\* Knob only, 9/16" thick
- 67\* Motor, Limit Timer (specify 240V; some units have lead wires on bottom)
- 69 Set-screw, 6/32 x 3/16"
- 71 Screw, center post 6/32 x 5/16"
- 72 Lock Washer, center post screw
- 74 Tube Assembly, specify long (Duncan Order No. KM 74)
- 75 Center Post
- 76 Nut, switch mounting 4/40 radio

**DAWSON  
PART  
NO.**

**DESCRIPTION**

- 78 Stand-off Bushing, switch mounting
- 80 Screw, flat head 6/32 x 5/16"
- 81 Screw, switch mounting 4/40 x 1-1/2" oval head
- 85\* Shim, motor mounting
- 93 Nylon washer, switch mounting
- 94 Switch block only
- 95 Switch block with contacts less center post & spring
- 96 Rear contact, modified
- 97 Nylon washer, contact
- 98 Nut, contact
- 99 Screw, 10/32 x 5/16"
- 102 Trigger, (1/16" x 3/4" x 1-1/8") Weight only (1/16" x 3/4" cavity)
- 103
- 109\* Front plate assembly, K-10 With #102, #103, #29, #30 less #49 and #16b
- 111\* Front plate assembly, LT-4K 20 hr. With #102, #103, #29, #30 less #49 and #16b

Drawings compliments of W.P. Dawson, Inc.

Order kiln-sitter parts from  
W.P. Dawson, Inc., 1147 East Elm,  
Fullerton, California 92631. Specify  
Dawson part number and name when  
ordering.

\*THIS PART IS USED IN ONLY ONE OR THE OTHER VERSION.



# APPENDIX E<sub>2</sub>

## DAWSON KILN-SITTER: EARLY SERIES MODELS K AND LT-3K

Installed only on Duncan DK 820 kilns with serial numbers between A 01011 - A 01448 and A 01500 through A 01806

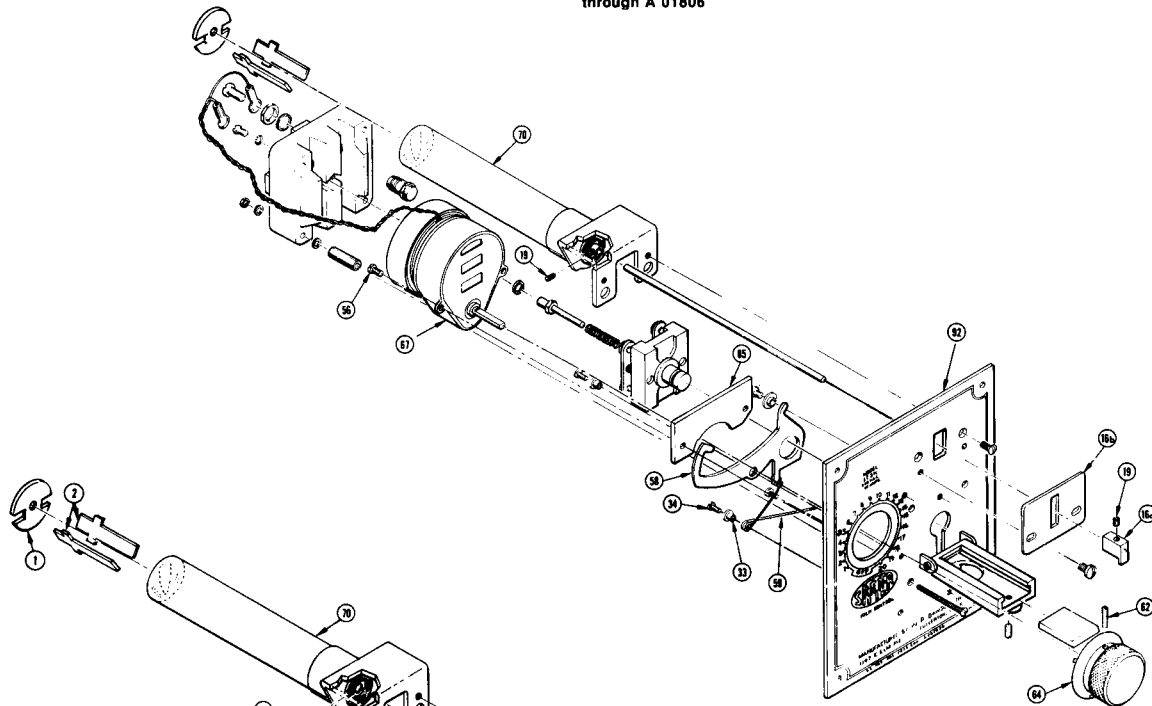

**Model LT-3K**

Used in all -2 and -4  
ES & DK Kilns

DAWSON PART NO.	DESCRIPTION
1	Firing Gauge (Duncan Order No. KM 1)
2	Pr. Cone Supports (Duncan Order No. KM 2)
3	Sensing Rod, specify long (Duncan Order No. KM 3)
15	Plunger Assembly
16a*	Claw with set-screw
16b	Guide Plate only
18	Screw, 6/32 x 1/4"
19*	Set-screw, 6/32 x 1/8"
24	Paper Washer, center post
26	Spring, center post
29	Set-screw, 8/32 x 3/8"
30	Pivot Pin
31	Lock
32	Spring, lock
33	Retainer, lock spring
34	Screw, 4/40 x 1/4"
35	Retainer, lock
36	Screw, lock spring 4/40 x 1/8"
36	Screw, motor mounting 6/32 x 1/4"
58	Locking Cam
59	Spring, locking cam
62	Set-screw, knob 10/32 x 1/2"
64	Knob only
67	Motor, limit Timer
70*	Tube Assembly, specify long
71	Screw, center post 6/32 x 5/16"
72	Lock Washer, center post screw
75	Center Post
76	Nut, switch mounting
78	Stand-off Bushing, switch mounting
80	Screw, flat head 6/32 x 5/16"
81	Screw, switch mounting 4/40 x 1-1/2" oval head
85	Shim, motor mounting

DAWSON PART NO.	DESCRIPTION
92*	Front Plate Assembly, LT-3K With #27 thru #30 less #16a and #16b
93	Nylon washer, switch mounting
94	Switch block only
95	Switch block with contacts less center post and spring
96	Rear contact, modified
97	Nylon washer, contact
98	Nut, contact
99	Screw, 10/32 x 5/16"
101*	Front Plate Assembly, K With #27 thru #30 less #16a and #16b
102	Trigger, (1/16" x 3/4" x 1-1/8")
103	Weight only (1/16" x 3/4" cavity)

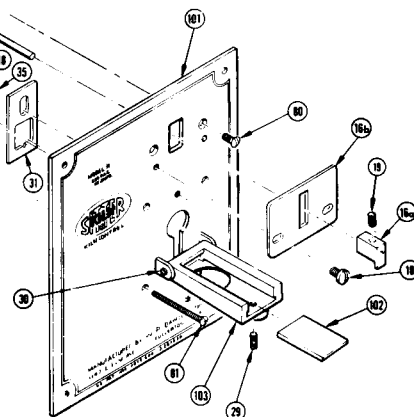

**Model K**

Used in all -1 and  
-3 ES & DK Kilns

Drawings compliments of W.P. Dawson, Inc.

Order kiln-sitter parts from W.P. Dawson, Inc., 1147 East Elm, Fullerton, California 92631. Specify Dawson part number and name when ordering.





## GLOSSARY

**ALUMINA** — An oxide formed when oxygen is combined with aluminum.

**AMMETER** — Instrument used to measure the amount of current flowing in a circuit.

**AMP** — Abbreviation for ampere; the unit of measurement of current.

**CIRCUIT** — A complete path through which electric current flows.

**CONDUCTOR** — A substance which permits current to pass through it with relative ease.

**CONTINUITY** — An uninterrupted path.

**CURRENT** — The movement of electrons along a conductor.

**FIRECLAY** — A clay capable of withstanding high temperatures.

**INSULATOR** — A material that is a very poor conductor, used to prevent the flow of electricity.

**KAOLIN** — A fine, unusually white clay that is used in ceramics and refractories as an absorbent and as a filler or extender.

**KILOWATT** — One thousand watts.

**MULTIMETER** — A multipurpose instrument combining the features of an ammeter, voltmeter and ohmmeter in one instrument.

**NEMA** — The abbreviation for the National Electrical Manufacturers Association, an organization of manufacturers which sets industry standards for the manufacturing of electrical devices.

**OHM** — Unit of measurement of electrical resistance.

**OHMMETER** — An instrument used for measuring electrical resistance in ohms.

**OSHA** — The Occupational Safety and Health Act and its administrative and enforcement body whose purpose is to ensure that all employers maintain safe and healthful working conditions for their employees.

**OXIDE** — A compound formed when oxygen combines with other materials (i.e., aluminum, iron, sulfur, etc.).

**REDUCTION FIRING** — Reducing the supply of oxygen in the kiln while firing.

**REFRACTORY** — A heat-resistant nonmetallic ceramic material.

**RESISTANCE** — The opposition offered to the flow of electrical current.

**SHORT CIRCUIT** — A path in which current flows where it is not wanted.

**VOLT** — Unit of measurement of voltage.

**VOLTAGE** — The force (or pressure) that moves current along a conductor.

**VOLTMETER** — An instrument used to determine the voltage existing between two points in a circuit.

**WATT** — The unit of measurement of electrical current's power.

# INDEX

- ALUMINA**, 7.1, 7.2
- BRICK**, 13.1 - 13.5
  - Cracks, 13.1
  - Damage from glaze, 13.1
  - Grooves, 13.1
  - Kiln floor
    - Cracks, 13.1
    - Maintenance, 13.2
    - Repair, 13.2
  - Replacement, 13.3 - 13.5
- Replacement**
  - Kiln bottom, 13.3, 13.5
    - When to replace, 13.2
  - Kiln brick, 13.2
  - Kiln lid, 13.4 - 13.5
- Wall brick**
  - Repair, 13.1
  - When to replace, 7.3, 13.1
- BUS BARS**, 5.1 - 5.2
- CIRCUIT**
  - Definition, 2.8
  - Open circuit
    - Definition, 2.8
    - Locating, 2.4, 2.8, 2.9, 2.10
  - Short circuit
    - Damage caused by, 2.8
    - Definition, 2.8
    - Locating, 2.8, 2.9 - 2.10
    - Preventing, 2.8, 4.1, 5.1, 7.3, 9.1
  - Size, for collar addition, 10.1
  - Testing equipment, 2.4 - 2.6
    - Element Tester, 2.4
    - Multimeter, 2.5 - 2.6
- CIRCUIT TESTER**
  - (See Element Tester)
- COLLARS**, 10.2 - 10.4
  - Installation, 10.2
  - Problems, 2.2, 10.1, 10.2
  - Testing, 10.2
- CONTROL PANEL**, 4.1 - 4.2
  - Removal, 4.1
  - Replacement, 4.2
- CONNECTING WIRES**, 9.1 - 9.5
  - Replacement, 9.1 - 9.4
    - KC 103 14", for Interconnect Receptacle, 9.1 - 9.2
    - KC 104 5" Interconnect Plug Ground Wire, 9.2
    - KC 113 5" Interconnect Receptacle Ground Wire, 9.2 - 9.3
    - KC 114 5", in Collar, 9.3
    - KC 124 5", with Pilot Light, 9.3 - 9.4
    - KC 138 14", Switch to Kiln-sitter or Element, 9.4 - 9.5
    - KC 139 9", Switch to Kiln-sitter or Element, 9.4 - 9.5
    - KC 148 14", with Pilot Light, 9.3 - 9.4
    - KC 149 9", with Pilot Light, 9.3 - 9.4
- CONNECTORS, ELEMENT**
  - (See Bus Bars, U-terminals)
- CORD**, 12.1 - 12.2
  - Altering, 12.1
  - Extension cord, 12.1
  - Replacement, 12.1 - 12.2
  - Strain Relief Bushing, 2.4, 12.1
  - Testing, 12.2
- CSA (CANADIAN STANDARDS ASSOCIATION)**, 1.1
- ELECTRICAL SCHEMATICS**
  - (See Appendices A1, B1, C1 and D1)
  - Wiring Diagram
- ELECTRICAL SERVICE/SUPPLY**, 3.1
  - Low voltage, 3.1
  - Size of service wiring for collar addition, 10.1
  - Three-phase power, 3.1
- ELEMENT**, 7.1 - 7.3
  - Coating, oxide, 7.1, 7.2
  - Connectors
    - (See Bus Bars, U-terminals)
  - Failure, causes of premature, 7.2
  - Life span, 7.1, 7.2
  - Locating damaged, 2.7
  - Ohm readings, 2.11
  - Pinning, 7.3
  - Replacement, 7.2
  - Staples, 7.3
  - Testing, 2.7
- ELEMENT STAPLES**, 7.3
- ELEMENT TESTER**, 2.4
  - Cautions, 2.4
  - Testing
    - Circuits, 2.8, 2.9
    - Cord, 12.2
    - Elements, 2.7
    - Grounding, kiln, 2.8 - 2.9
    - Switches, 2.7
- FIRING**
  - Schedules, changing, 6.3
  - Time, length of
    - Altering, 6.3
    - Long (slow), 3.1, 6.3
    - Venting period, 6.3
  - Reduction, 7.2
  - Uneven, 6.3
- GROUNDING**, 4.1
  - Testing
    - Kiln, 2.8 - 2.9
    - Wall receptacle, 11.2
- HEAT SHIELD**, 4.1
- HEAT SETTINGS**
  - (See Switch, settings)
- HINGES**, 13.4
- INSULATORS**, 5.1 - 5.2
- INTERCONNECT UNIT**, 10.1 - 10.3
  - Difference, 15-amp and 20-amp, 10.2
  - Locating faulty, 10.1
  - Problems, 2.2, 10.1, 10.2
  - Replacement
    - Plug, 10.3
    - Receptacle, 10.3
- INTERCONNECT RECEPTACLE BRACKET**, 10.2
- KILN**
  - Electrical Schematics
    - (See Appendices A1, B1, C1 and D1)
  - Electrical system, 12.1
  - Installation, 1.1 - 1.2
  - Ohm Readings Chart, 2.11
  - Problems
    - Collar will not fit, 10.2
    - Functioning improperly, 2.2, 2.3, 3.1
      - Switch, 6.2
    - Kiln not grounded, 2.8 - 2.9
    - Not functioning
      - Circuit breaker tripped, 2.3
      - Collar, 2.2, 10.1
      - Elements, 2.7
      - Fuse blown, 2.3
      - Kiln, 2.3
      - Kiln section, 2.2, 10.1
      - Pilot light, 2.3, 6.3

- Safety Timer, 2.10, 8.2
- Switch, 2.7 - 2.8
- Slow firing, 2.1 - 2.2, 3.1, 6.3
- Uneven firing, 2.3, 6.3
- Tests
  - Electrical soundness, 2.8 - 2.10
  - Predelivery, 2.10
  - Troubleshooting Chart, 2.1 - 2.3
  - Voltage requirement, 3.1, 12.1
  - Wiring Diagram
    - (See Appendices A3, A5, B3, B5, C3, D3 and D5)
- KILN-SITTER, DAWSON, 8.1 - 8.5**
  - Adjustment, 8.1 - 8.2
  - Early Series models, K and LT-3K, 8.1, 8.2, 8.3, 8.4
    - (Also see Appendix E2)
  - Maintenance, 8.1 - 8.2
  - Problems
    - Cone supports, 8.2
    - Counterweight, 8.1
    - Guide plate, 8.5
    - Sensing rod, 8.2, 8.5
    - Timer motor, 2.10, 8.2
    - Tube assembly, 8.5
  - Replacement
    - Sensing rod, 8.3 - 8.4
    - Tube assembly, 8.4
    - (Also see Appendix E1)
- LID BRACE, LOCKING, 13.4**
- LID, KILN**
  - DK Models, 13.4
  - ES Models, 13.5
- MULTIMETER, 2.4 - 2.6**
  - Setting up for
    - Ohm-scale reading, 2.5
    - Volt-scale reading, 2.6
  - Testing
    - Circuits, 2.8 - 2.10
    - Cord, 12.2
    - Elements, 2.7
    - Grounding, kiln, 2.8 - 2.9
    - Safety Timer motor, 2.10
    - Switches, 2.7 - 2.8
    - Voltage, at wall receptacle, 11.2
    - Wall receptacle wiring, 11.2
- OHMS**
  - Limitation, Element Tester, 2.4
  - Measuring, 2.7 - 2.10
  - Ohm Readings Chart, 2.11
  - Using multimeter to read, 2.6
- OXIDE**
  - Alumina, 7.1, 7.2
  - Iron-chromium, 7.1
- PILOT LIGHT**
  - Not operating, 2.3, 6.3
  - Replacement, 9.3 - 9.4
- PYROMETER, 14.1 - 14.2**
- RECEPTACLES**
  - (See Interconnect Unit)
  - (See Wall Receptacles)
- REDUCTION FIRING, 7.2**
- SAFETY, 1.1 - 1.2**
  - Electrical soundness, kiln, 2.8 - 2.10
  - Grounding, kiln, 2.8 - 2.9
  - Installation, kiln, 1.2
- SAFETY TIMER**
  - Problems, 2.10, 8.2
  - Testing, 2.10
- SWITCH, INFINITE, 6.1 - 6.4**
  - Calibration
    - Checking, 6.2
    - Correcting, 6.2
    - Effect of voltage on, 6.2
  - Cycling, 6.1 - 6.2
  - Operation, 6.1
  - Pilot light, 6.3
  - Popping, 6.3
  - Replacement, 6.4
  - Settings
    - Altering, how to, 6.2 - 6.3
    - Altering, when to, 6.3
  - Testing, 2.7 - 2.8
- TEMPERATURE**
  - Effect on
    - Brick, 13.1
    - Connecting wires, 9.1
    - Elements, 7.2
    - Not attained by kiln, 2.2
    - Reducing features, control panel, 4.1
- TESTING**
  - Circuits, 2.8, 2.9 - 2.10
  - Cord, 12.2
  - Electrical soundness, kiln, 2.8 - 2.10
  - Elements, 2.7
  - Grounding, kiln, 2.8 - 2.9
  - Safety Timer motor, 2.10
  - Switches, 2.7 - 2.8
  - Voltage, 11.2
  - Wall receptacle wiring, 11.2
- THERMOCOUPLE**
  - (See Pyrometer)
- TROUBLESHOOTING**
  - Chart, 2.1 - 2.3
  - Equipment
    - Element Tester, 2.4
    - Multimeter, 2.4 - 2.6
  - Pilot light, not lighting, 6.3
  - Slow-firing kiln, 2.1 - 2.2, 6.3
  - Tests
    - Circuits, 2.9, 2.10
    - Cord, 12.2
    - Electrical soundness, kiln, 2.8 - 2.10
    - Elements, 2.7
    - Grounding, kiln, 2.8 - 2.9
    - Predelivery, 2.10
    - Safety Timer
      - Continuity, 2.10
      - Gears, 2.10
    - Switches, 2.7 - 2.8
    - Wall receptacle wiring, 11.2
    - Uneven-firing kiln, 2.3, 6.3
- UL (UNDERWRITERS LABORATORY INC.), 1.1**
- U-TERMINALS, 5.1 - 5.2**
- VOLTAGE**
  - Effect on
    - Kiln firing, 3.1
    - Switch calibration, 6.2
  - Low service/supply, 3.1
    - How to correct, 3.1
  - Measuring, 2.6
  - Requirement
    - How to change, 3.1
    - Supply necessary, 3.1, 12.1
  - Testing, wall receptacle, 11.2
  - Three-phase, 3.1
  - Using multimeter to read, 2.6
- WALL RECEPTACLES, 11.1 - 11.2**
  - Installation, 1.1, 11.1
  - NEMA configuration, appropriate, 11.1
  - Testing wiring, 11.2
- WIRES**
  - (See Connecting Wires)
- WIRING**
  - Diagram
    - (See Appendices A3, A5, B3, B5, C3, D3 and D5)
  - Electrical Schematics
    - (See Appendices A1, B1, C1 and D1)